

# FENSTER INNOVATIONEN 2024



ZERO  
0,79 W/m<sup>2</sup>k



Das „neue“ Loft  
0,85 W/m<sup>2</sup>k



Integral 2.0  
0,68 W/m<sup>2</sup>k



PURE[WOOD]  
0,82 W/m<sup>2</sup>k

ZERO

LOFT

Integral 2.0

PURE[WOOD]

# ZERO

flächenbündig

kantig

reduziert

81 mm Bautiefe



ZERO

# System

Bautiefe 81 mm

Uf-Wert 1,2

Ansichtsbreite 111 mm

Glas Ug 0,5 0,79 W/m<sup>2</sup>k Uw

Glasstärke 48 mm mind.



# Außen

Ansicht von Rahmen,  
Flügel und Glas  
flächenbündig.

2 mm Kanten-Radien  
für moderne Optik.



# Innen

Ansicht mit  
Dekorfolie in  
Anthrazitgrau Ulti-Matt  
oder Black Ulti-Matt.



Anthrazitgrau Ulti-Matt

Black Ulti-Matt

## kantige Optik

Innen eckige Glasleisten  
für eine kantige Ansicht.\*

2 mm Kanten-Radien für  
Modernes Design.

\* nur für Flügel mit 48 mm Glasdicke



Anthrazitgrau Ulti-Matt

# Das Upgrade!

Schlanker ip-Steckgriff  
mit reduzierter Rosette  
gegen Aufpreis.



Griff Edelstahl  
Profil weiß



Griff schwarz eloxiert  
Profil foliert anthrazit grau Ulti-matt



Griff mittelbronze eloxiert  
Profil foliert black Ulti-matt

# ip-Select-Griffe

ip-Steckgriffe im besonderen  
Design in drei verschiedenen  
Eloxalen gegen Aufpreis.

Weitere Steckgriffe  
auf Anfrage möglich.



Design Hans Kollhoff  
schwarz eloxiert



Design Jasper Morrison  
schwarz eloxiert



Design Heike Falkenberg  
schwarz eloxiert



# Zu empfehlen.

Passend zur reduzierten,  
kantigen Innen- und Außen-  
ansicht empfehlen wir  
verdeckt liegende Beschläge.



## ZERO

RAL-Farben

Eloxal- und Spezialfarben

Strukturen

ZERO



Moosgrün RAL 6005 matt  
Pulver IG 5803 A6005 0A00



Achatgrau RAL 7038 matt  
Pulver IG 5803 A7038 0A00



Schokobraun RAL 8017 matt  
Pulver IG 5803 A8017 0A00



Stahlblau RAL 5011 matt  
Pulver IG 5803 A5011 0A00



Basaltgrau RAL 7012 matt  
Pulver IG 5803 A7012 0A00

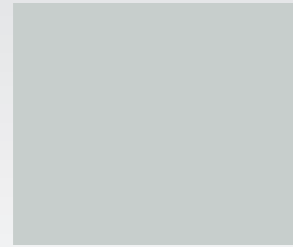

Lichtgrau RAL 7035 matt  
Pulver IG 5803 A7035 0A00



Schwarzbraun RAL 8022 matt  
Pulver IG 5803 A8022 0A00



Purpurrot RAL 3004 matt  
Pulver IG 5803 A3004 0A00



Schiefergrau RAL 7015 matt  
Pulver IG 5803 A7015 0A00

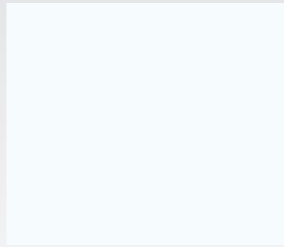

Verkehrsweiß RAL 9016 matt  
Pulver IG 5803 A9016 0A00



Anthrazitgrau RAL 7016 matt  
Pulver IG 5803 A7016 0A00

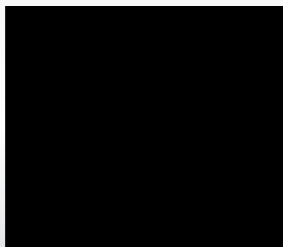

Graphit schwarz RAL 9011 matt  
Pulver IG 5803 A9011 0A00

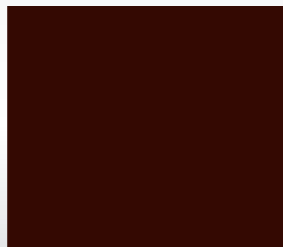

Mahagonibraun RAL 8016 matt  
Pulver IG 5803 A8016 0A00



Verkehrsweiß RAL 9016 feinstruktur  
Pulver IG 581 MA 9016 0A00



C 32  
Eloxier E6/C-32



C 35  
Eloxier E6/C-35

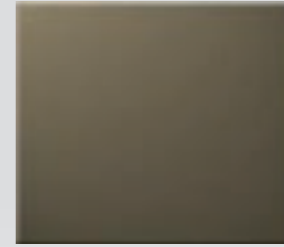

C 33  
Eloxier E6/C-33



C 34  
Eloxier E6/C-34

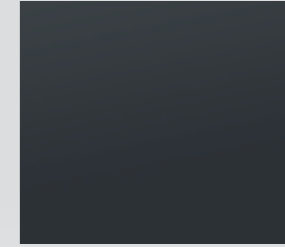

DB 703 glatt  
Pulver Axalta AE 30257750122

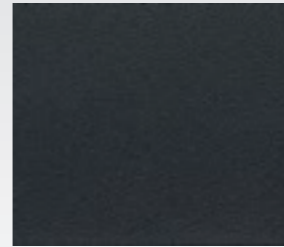

DB 703 Feinstruktur  
Pulver Inver PE/P/Q 76505



Schwarzgrau RAL 7021 matt  
Pulver IG 5803 A7021 0A00



DB 702 glatt  
Pulver IG 5803 E9007 0A10



DB 702 Feinstruktur  
Pulver IG 581 ME 9007 0A10

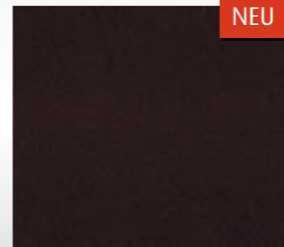

Dunkelbraun Stumpfmatt FS RAL 8077  
Pulver IG 591 TA 8556 0A00

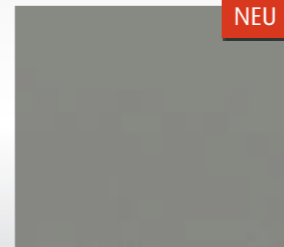

Steingrau RAL 7030 Feinstruktur  
Pulver IG 581 MA 7030 0A00

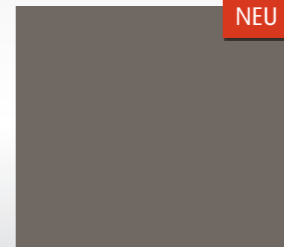

Beigegrü RAL 7006 matt  
Pulver IG 5803 A7006 0A00

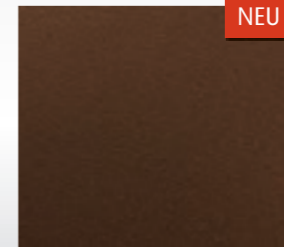

Architectural Bronze  
Pulver IG 591 TE 81576R35

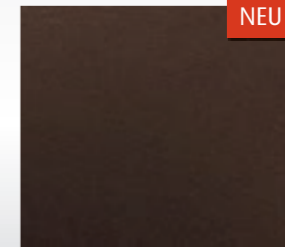

Marrone 04 metallic Feinstruktur  
Pulver Tiger 29/60740

Aufgrund drucktechnischer Gegebenheiten können Farbabweichungen zwischen den Darstellungen im Katalog und den Original-Produkten auftreten. Ihr Fachhändler zeigt Ihnen gerne die Original-Farbmuster.

Aufgrund drucktechnischer Gegebenheiten können Farbabweichungen zwischen den Darstellungen im Katalog und den Original-Produkten auftreten. Ihr Fachhändler zeigt Ihnen gerne die Original-Farbmuster.

# ZERO Technik

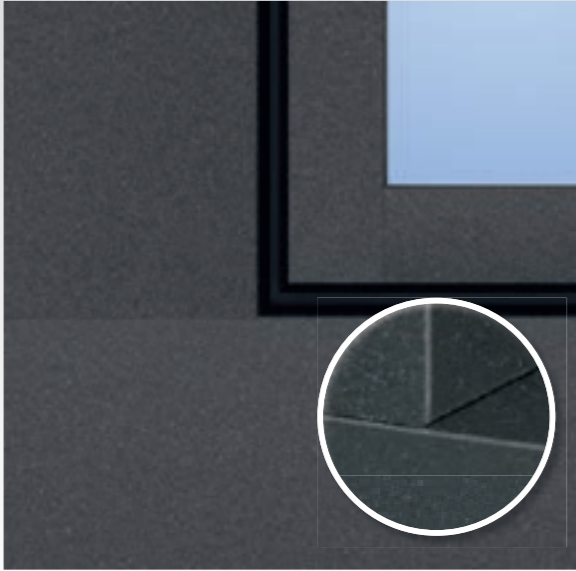

mattiert  
(Standard)

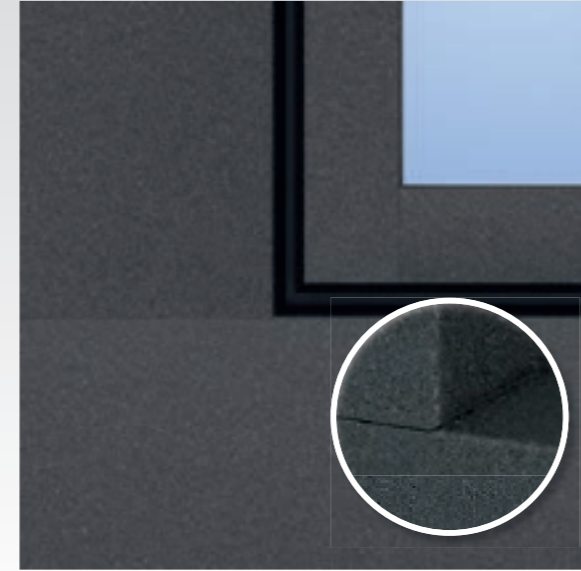

fein strukturiert  
(auf Bestellung)



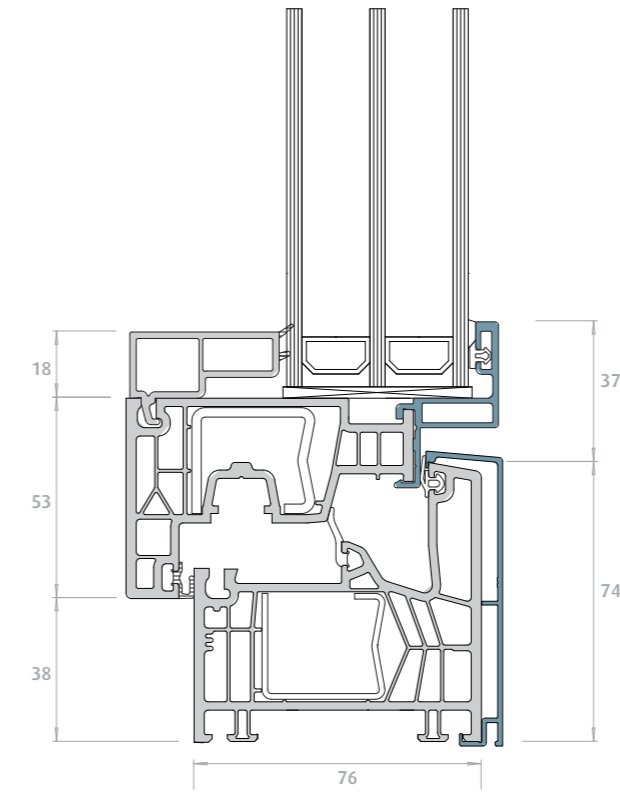
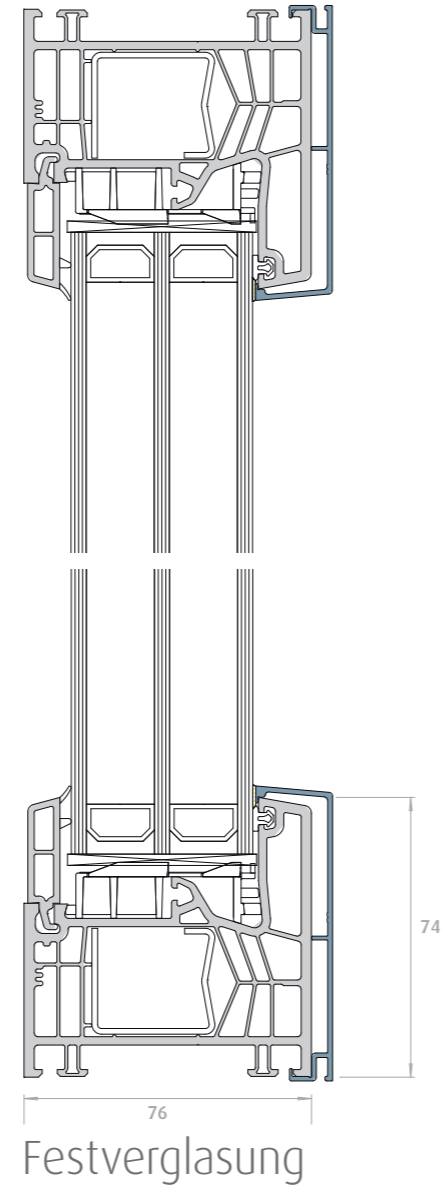
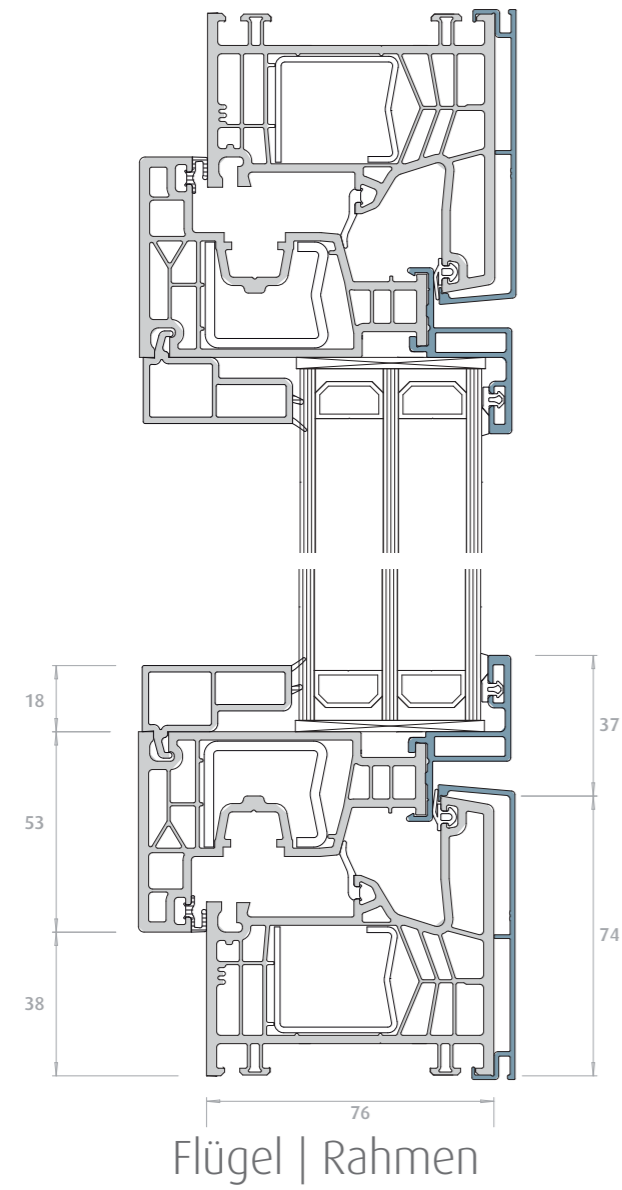

Flügel | Rahmen

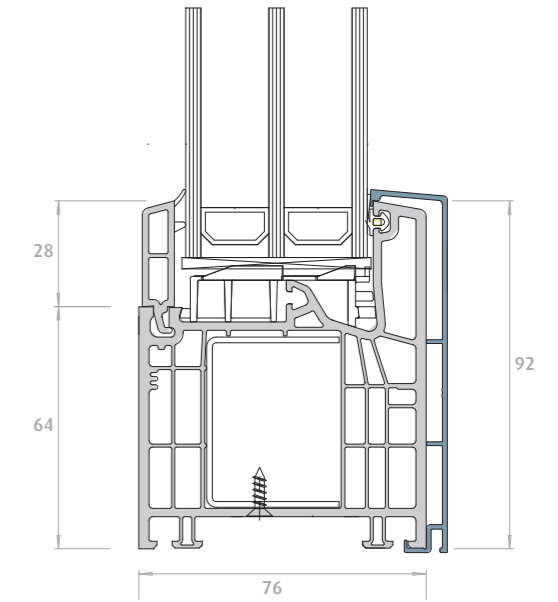

FIB  
mit breitem Blendrahmen

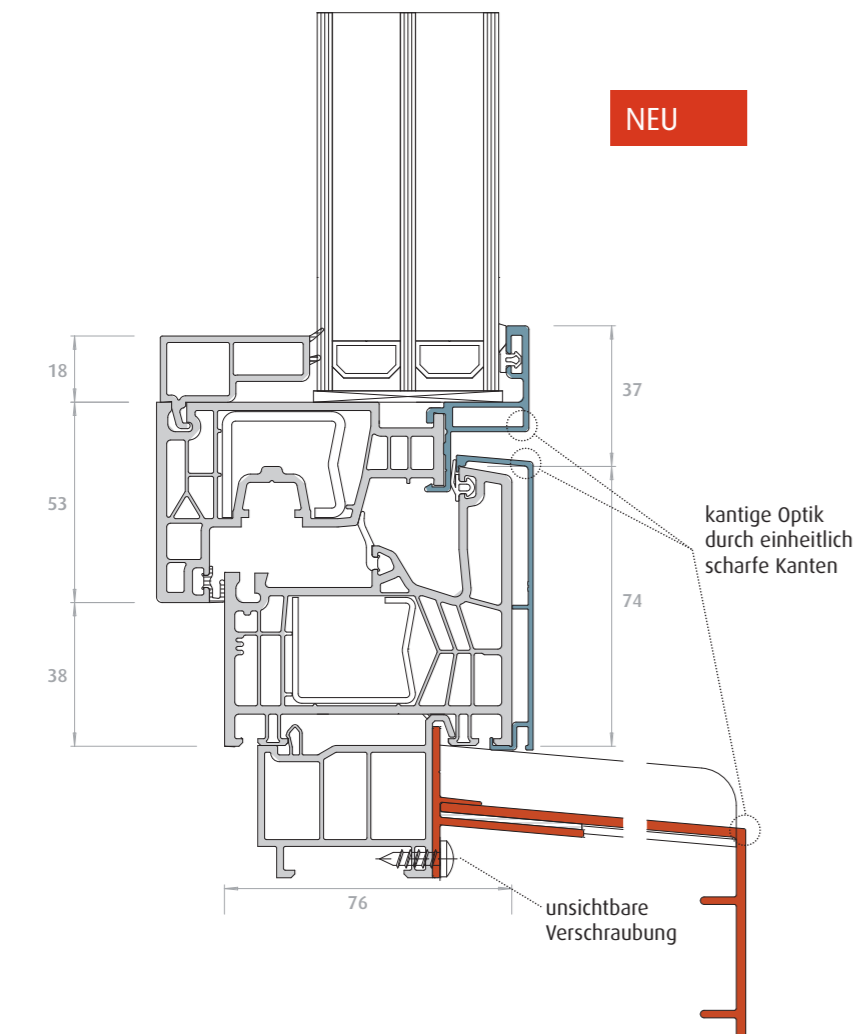

ip-Fensterbank 190 mm Ausladung

59,- Euro/lfm Bruttopreis abzgl. Rabatt  
+ 2 Endstücke 19,- Euro brutto

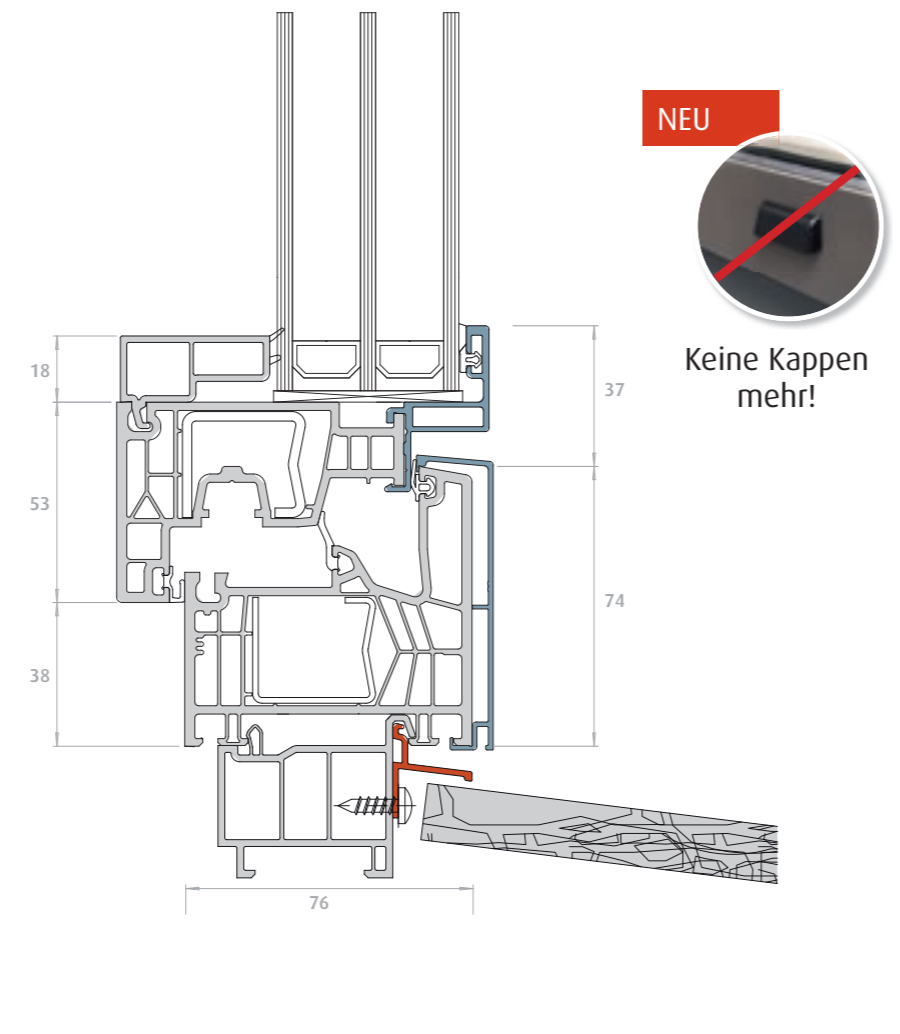

Steinbankanschluss

verdeckte Entwässerung nach unten – keine Kappen sichtbar  
18,- Euro/lfm Bruttopreis abzgl. Rabatt

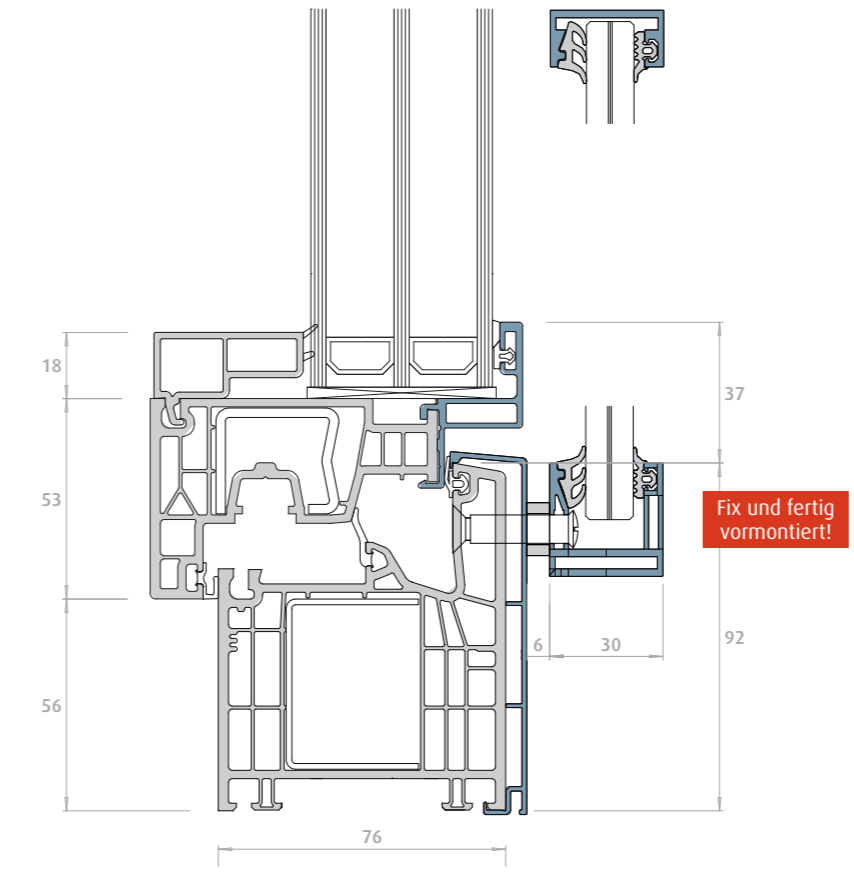

Glasabsturzicherung Typ2  
und breiter Rahmen

Vierseitiger Rahmen mit Aluabdeckung,  
12 mm Sicherheitsglas, bis 140 cm breit.

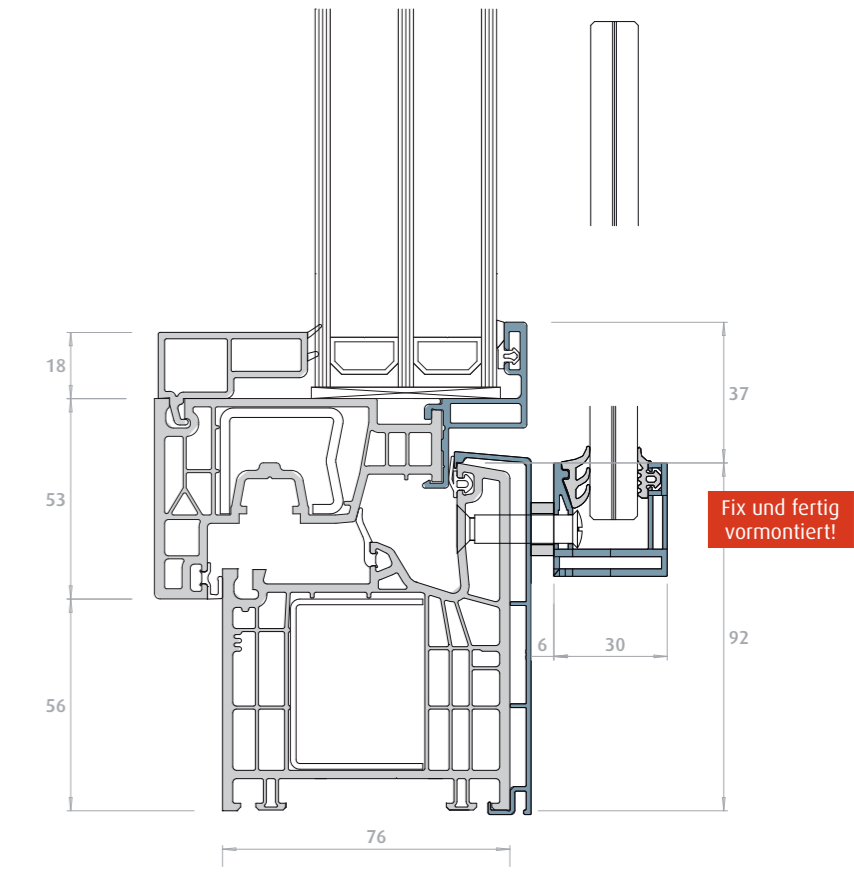

Glasabsturzicherung Typ1  
und breiter Rahmen

Dreiseitiger Rahmen, Glas oben geschliffen,  
12 mm Sicherheitsglas, bis 140 cm breit.

# TECHNIKMAPPE LOFT-FENSTER



LOFT





Der Industrie-Klassiker

## LOFT-Fenster

mit innovativer Beschlags-  
technik und 3-fach-Glas  
für die Anforderungen von  
heute.



LOFT



# System

Bautiefe	75 mm
Uf-Wert	1,2
Ansichtsbreite	85 mm
Glas	0,7 W/m <sup>2</sup> k
Glasstärke	36 mm



# Außen

Aluminium-Sprossen  
in Stahlfensteroptik.

Besonders schlanke Optik  
durch eine Sprossenbreite  
von nur 26 mm.





# Innen

Lichtdurchflutete Räume durch raumhohe Alurahmenfenster.

Hochwertige Griffe für den Anspruch auf das Besondere im Detail.



# Griffe

mit Knopf oder Schloß und auf Wunsch in passenden Farben oder Beschichtungen.



Griff Aluminium, RAL 9005 matt

Griff Aluminium, RAL 9005 matt mit Knopf

Griff Aluminium, RAL 9005 matt mit Schloß

## Wir empfehlen:

Passend zur reduzierten,  
kantigen Innen- und Außenansicht  
verdeckt liegende Beschläge.



## LOFT-Fenster

RAL-Farben

Eloxal- und Spezialfarben

Strukturen



Moosgrün RAL 6005 matt  
Pulver IG 5803 A6005 0A00



Achatgrau RAL 7038 matt  
Pulver IG 5803 A7038 0A00



Schokobraun RAL 8017 matt  
Pulver IG 5803 A8017 0A00



Stahlblau RAL 5011 matt  
Pulver IG 5803 A5011 0A00



Basaltgrau RAL 7012 matt  
Pulver IG 5803 A7012 0A00



C 32  
Eloxiert E6/C-32



C 35  
Eloxiert E6/C-35

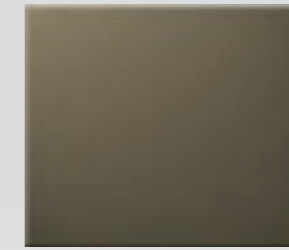

C 33  
Eloxiert E6/C-33

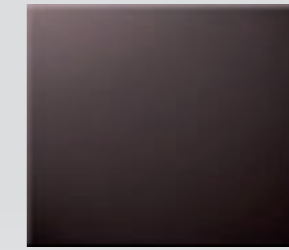

C 34  
Eloxiert E6/C-34

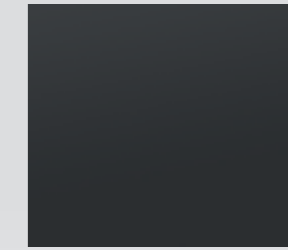

DB 703 glatt  
Pulver Axalta AE 30257750122

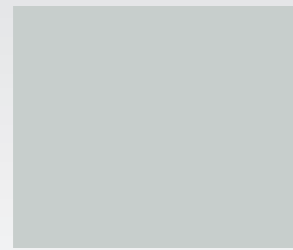

Lichtgrau RAL 7035 matt  
Pulver IG 5803 A7035 0A00

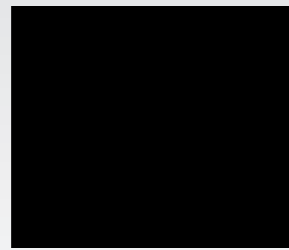

Schwarzbraun RAL 8022 matt  
Pulver IG 5803 A8022 0A00



Purpurrot RAL 3004 matt  
Pulver IG 5803 A3004 0A00



Schiefergrau RAL 7015 matt  
Pulver IG 5803 A7015 0A00

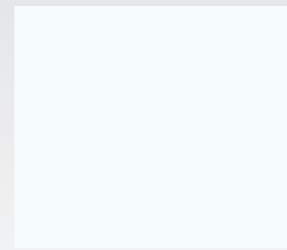

Verkehrsweiß RAL 9016 matt  
Pulver IG 5803 A9016 0A00

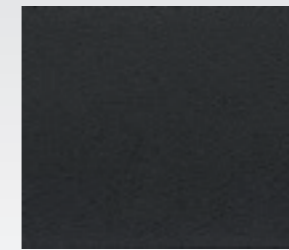

DB 703 Feinstruktur  
Pulver Inver PE/P/Q 76505



Schwarzgrau RAL 7021 matt  
Pulver IG 5803 A7021 0A00

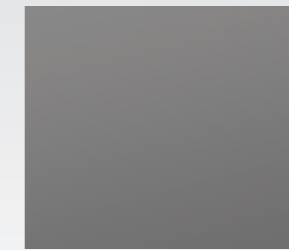

DB 702 glatt  
Pulver IG 5803 E9007 0A10



DB 702 Feinstruktur  
Pulver IG 581 ME 9007 0A10



Anthrazitgrau RAL 7016 matt  
Pulver IG 5803 A7016 0A00

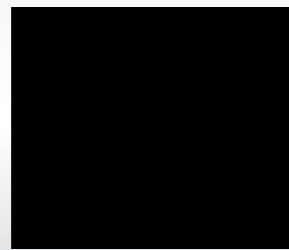

Graphit schwarz RAL 9011 matt  
Pulver IG 5803 A9011 0A00



Mahagonibraun RAL 8016 matt  
Pulver IG 5803 A8016 0A00

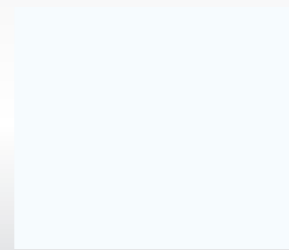

Verkehrsweiß RAL 9016 feinstruktur  
Pulver IG 581 MA 9016 0A00

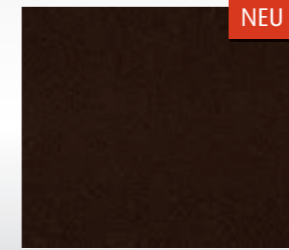

Dunkelbraun Stumpfmatt FS RAL 8077  
Pulver IG 591 TA 8556 0A00



Steingrau RAL 7030 Feinstruktur  
Pulver IG 581 MA 7030 0A00

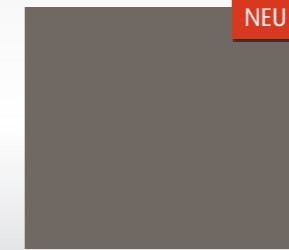

Beigegrü RAL 7006 matt  
Pulver IG 5803 A7006 0A00

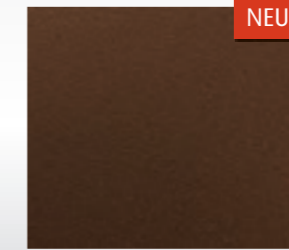

Architectural Bronze  
Pulver IG 591 TE 81576R35

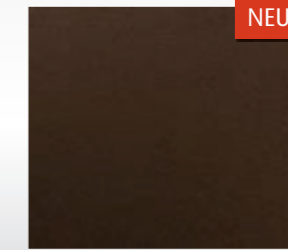

Marrone 04 metallic Feinstruktur  
Pulver Tiger 29/60740

# LOFT-Fenster Technik

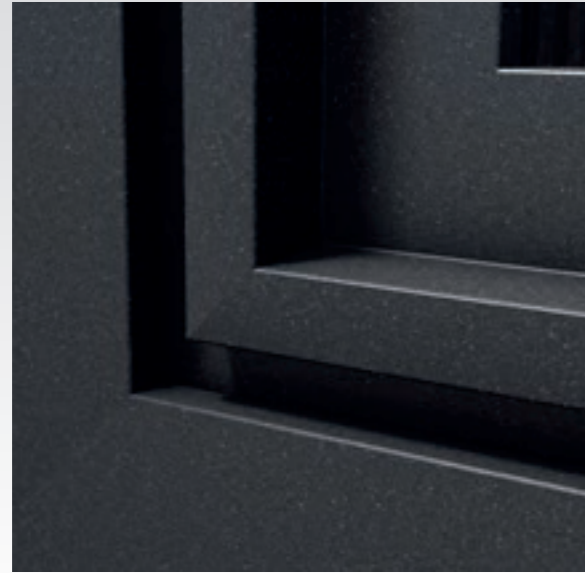

mattiert  
(Standard)

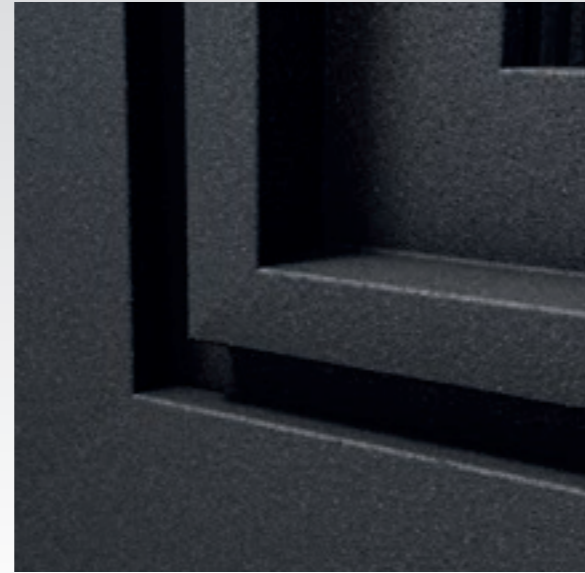

fein strukturiert  
(auf Bestellung)

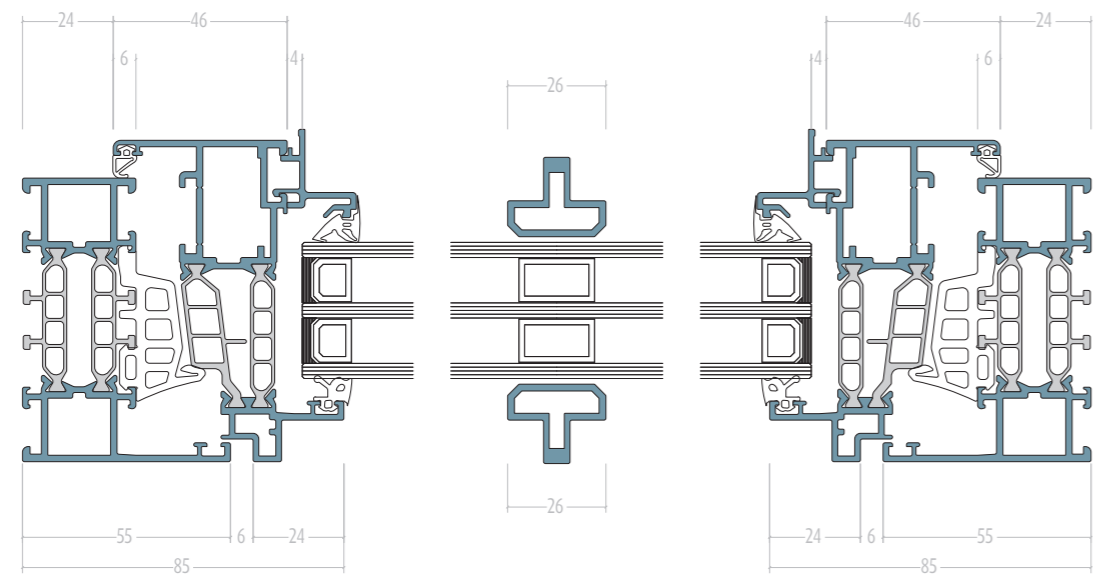
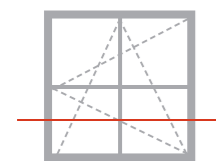

Flügel | Rahmen

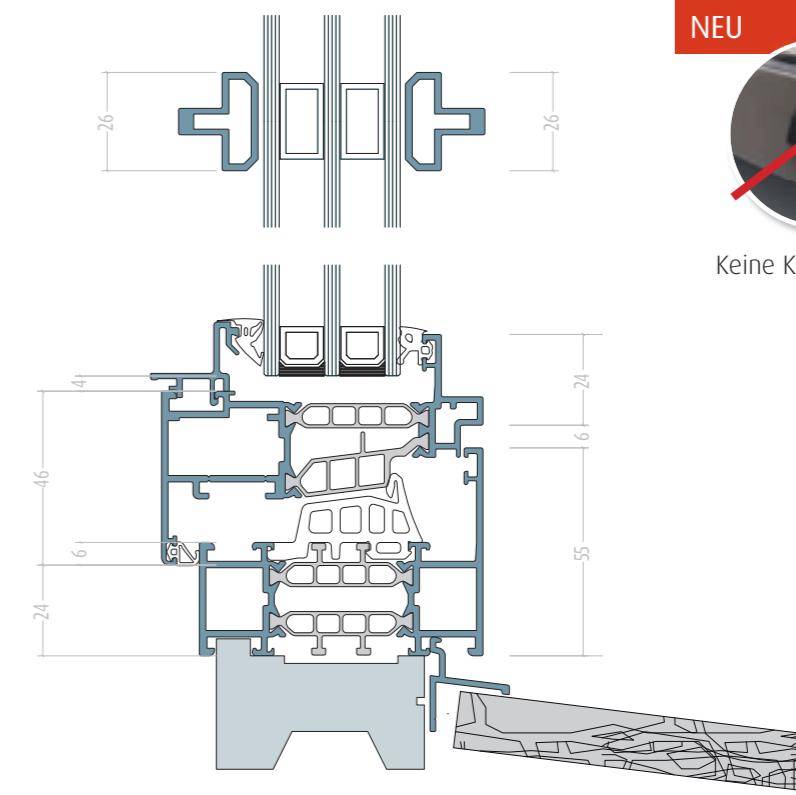
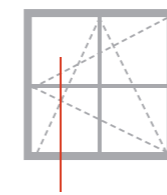

Steinbankanschluß

verdeckte Entwässerung nach unten - keine Kappen sichtbar  
18,- Euro/lfm Bruttopreis abzgl. Rabatt



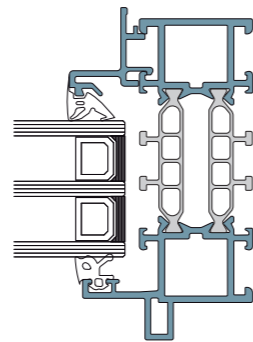
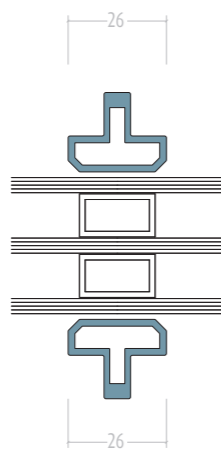
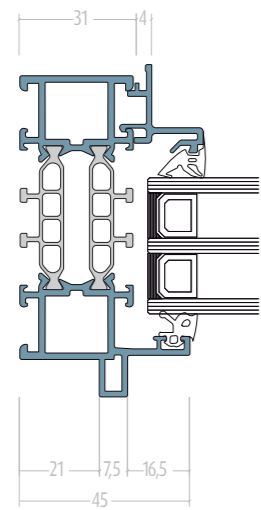
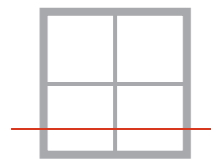

FIB

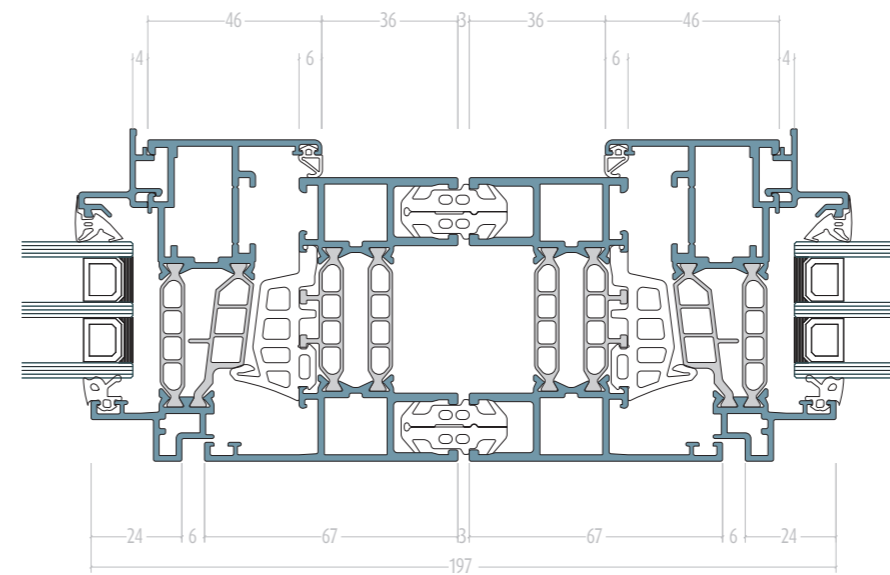
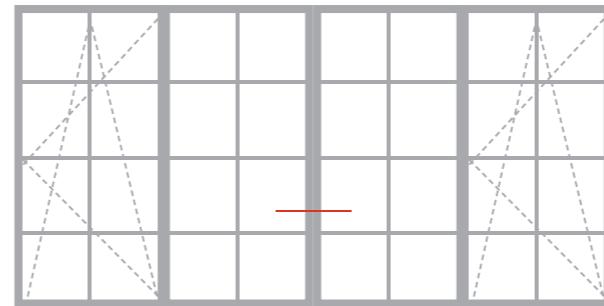

Kopplung

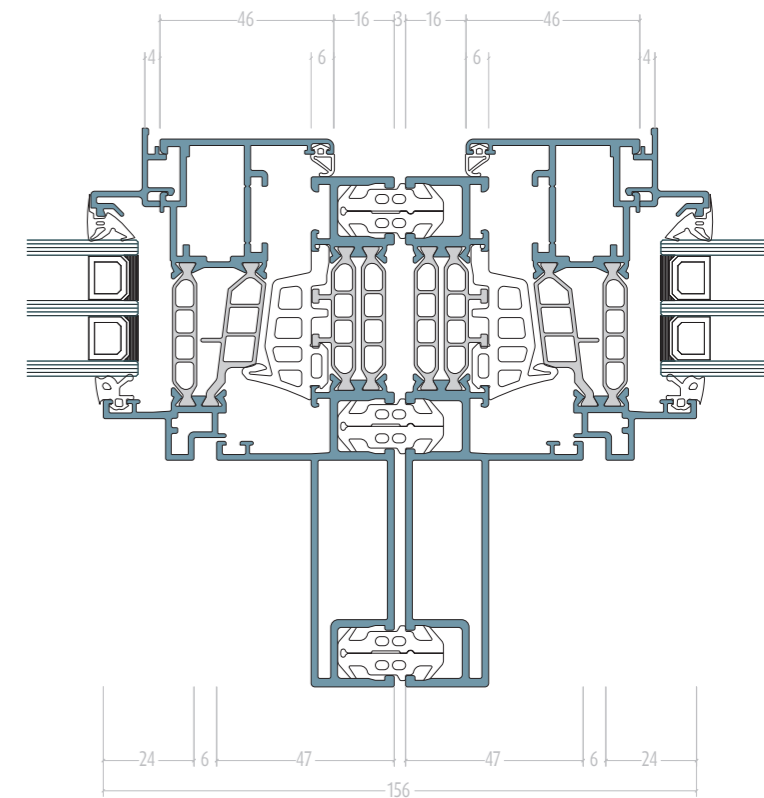

Kopplung mit Statikpfosten

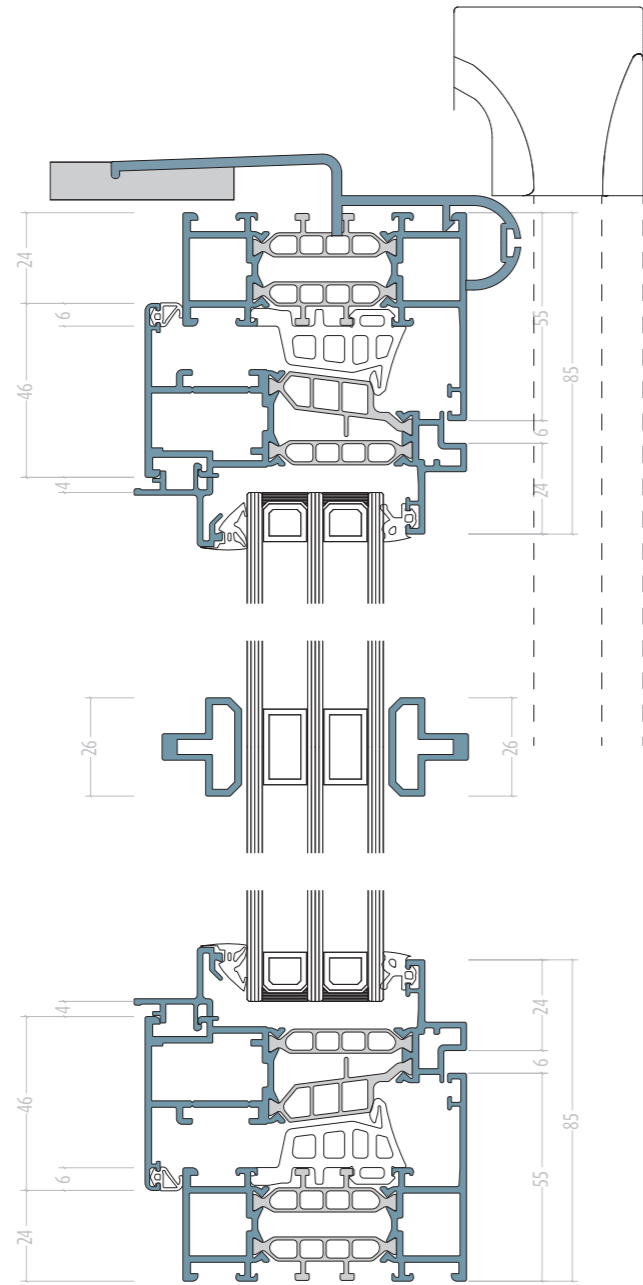
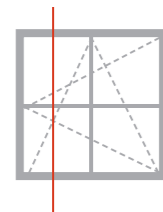

Rollladentraverse

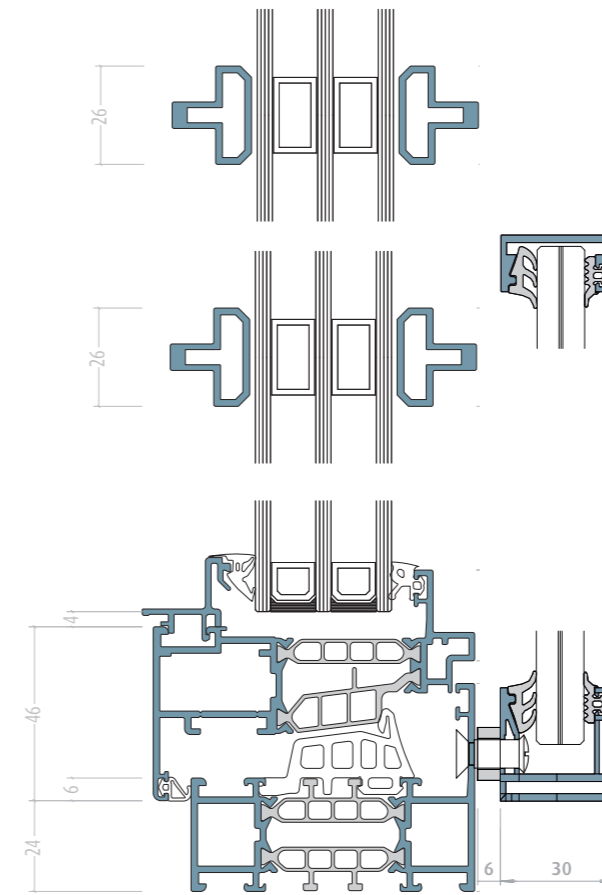

Glasabsturzicherung Typ2  
und breiter Rahmen

Vierseitiger Rahmen mit Aluabdeckung,  
12 mm Sicherheitsglas, bis 140 cm breit.

Fix und fertig  
vormontiert!

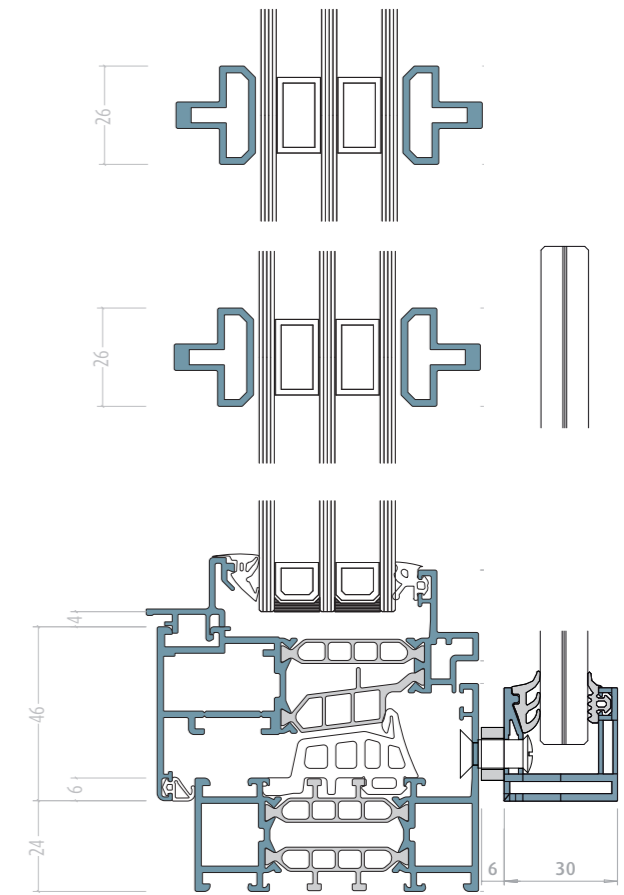

Glasabsturzicherung Typ1  
und breiter Rahmen

Dreiseitiger Rahmen, Glas oben geschliffen,  
12 mm Sicherheitsglas, bis 140 cm breit.

Fix und fertig  
vormontiert!

# INTEGRAL 2.0

Das innovative System:  
Coextrudiert oder  
mit Aludeckschale  
entsprechend den  
Anforderungen KfW40.



Integral 2.0

## Integral 2.0 Acrylcolor | Aludeck

Bautiefe	82,5   83	mm
Ansichtsbreite	100   103	mm
Uf	0,88   0,88	W/m <sup>2</sup> k
Ug (48 mm)	0,5   0,5	W/m <sup>2</sup> k
Uw	0,68   0,68	W/m <sup>2</sup> k

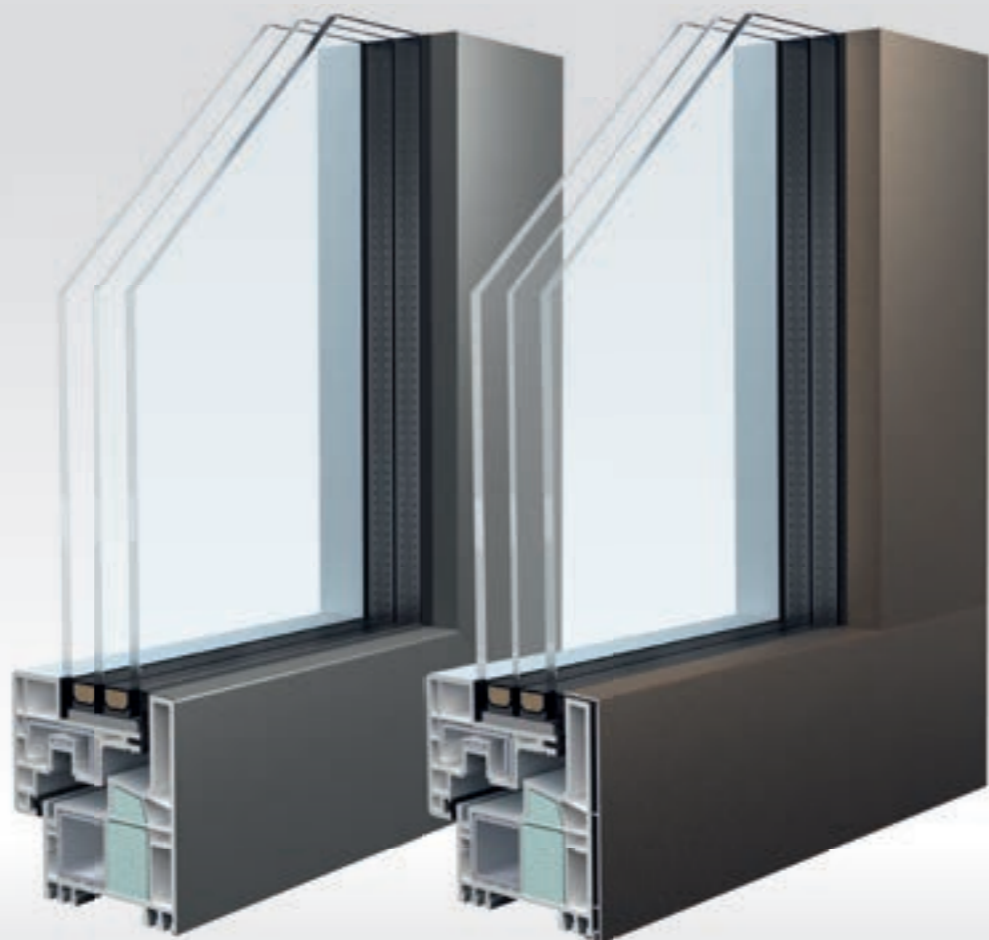

Außenansicht Rahmen:  
Flügel verdeckt liegend.  
Eckige Kanten  
für moderne Optik.



Innenansicht Flügel:

Passend zur reduzierten  
Außenansicht.

Verdeckt liegende Beschläge  
ohne Aufpreis.



Das Upgrade!

Schlanker ip-Steckgriff  
mit stabiler Verschraubung  
im Stahlkern  
gegen Aufpreis.



Griff Edelstahl  
Profil weiß



Griff schwarz eloxiert  
Profil RAL 7016



Griff mittelbronze eloxiert  
Profil RAL 9005



ip-Select-Griffe  
 im besonderen Design  
 in verschiedenen Eloxalen  
 gegen Aufpreis.

Weitere Steckgriffe  
 auf Anfrage möglich.



Design Hans Kollhoff  
 schwarz eloxiert

Design Jasper Morrison  
 schwarz eloxiert

Design Heike Falkenberg  
 schwarz eloxiert



C 32  
 Eloxiert E6/C-32

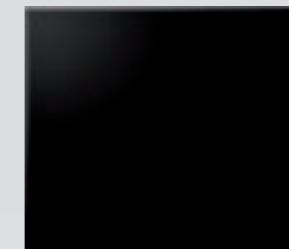

C 35  
 Eloxiert E6/C-35

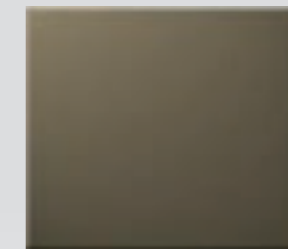

C 33  
 Eloxiert E6/C-33

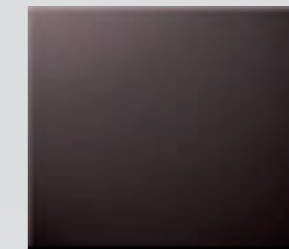

C 34  
 Eloxiert E6/C-34

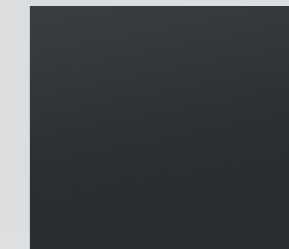

DB 703 glatt  
 Pulver Axalta AE 30257750122

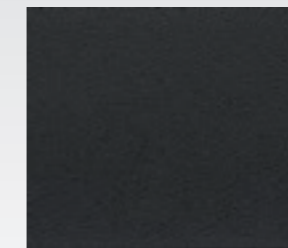

DB 703 Feinstruktur  
 Pulver Inver PE/P/Q 76505



Schwarzgrau RAL 7021 matt  
 Pulver IG 5803 A7021 0A00

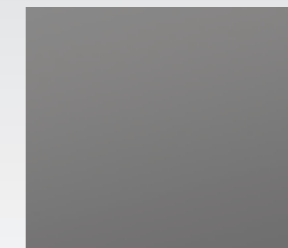

DB 702 glatt  
 Pulver IG 5803 E9007 0A10



DB 702 Feinstruktur  
 Pulver IG 581 ME 9007 0A10

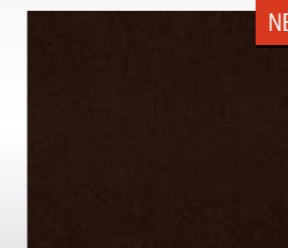

Dunkelbraun Stumpfmatt FS RAL 8077  
 Pulver IG 591 TA 8556 0A00



Steingrau RAL 7030 Feinstruktur  
 Pulver IG 581 MA 7030 0A00



Beigegrau RAL 7006 matt  
 Pulver IG 5803 A7006 0A00

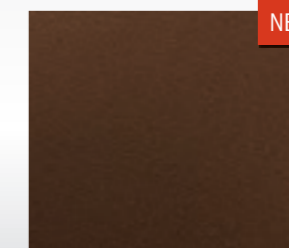

Architectural Bronze  
 Pulver IG 591 TE 81576R35

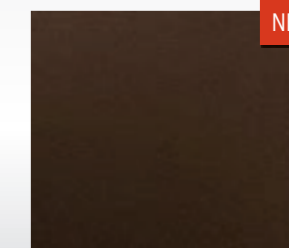

Marrone 04 metallic Feinstruktur  
 Pulver Tiger 29/60740

## Integral 2.0 Aludeck

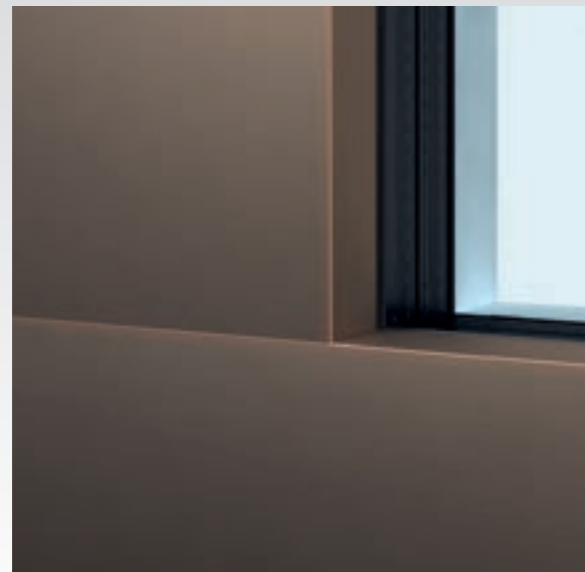

mattiert

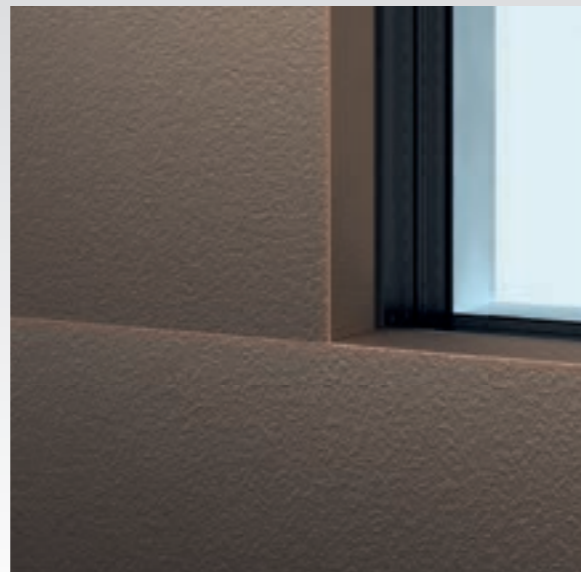

fein strukturiert

Technik

Integral 2.0 Acrylcolor | Aludeck

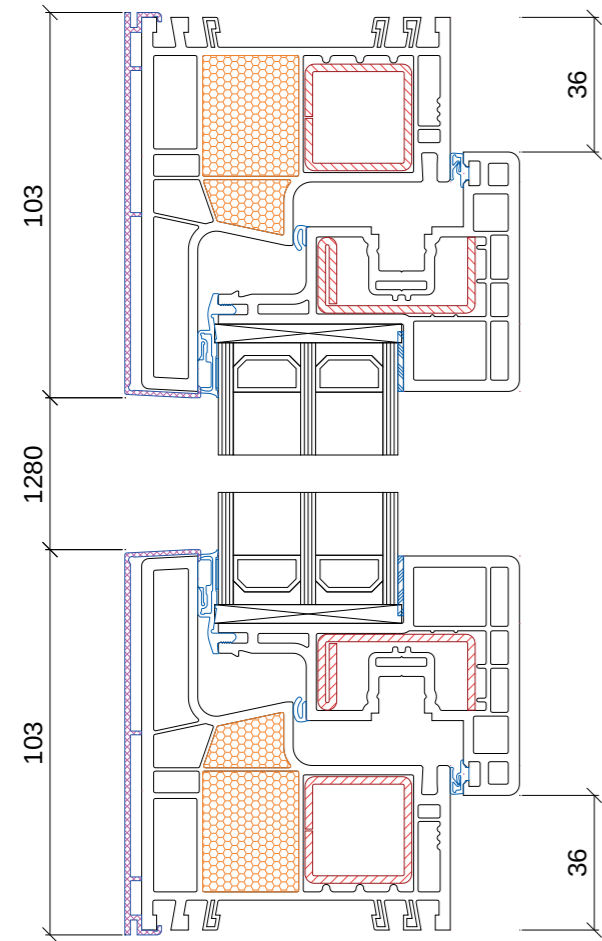

mit Aludeckschale

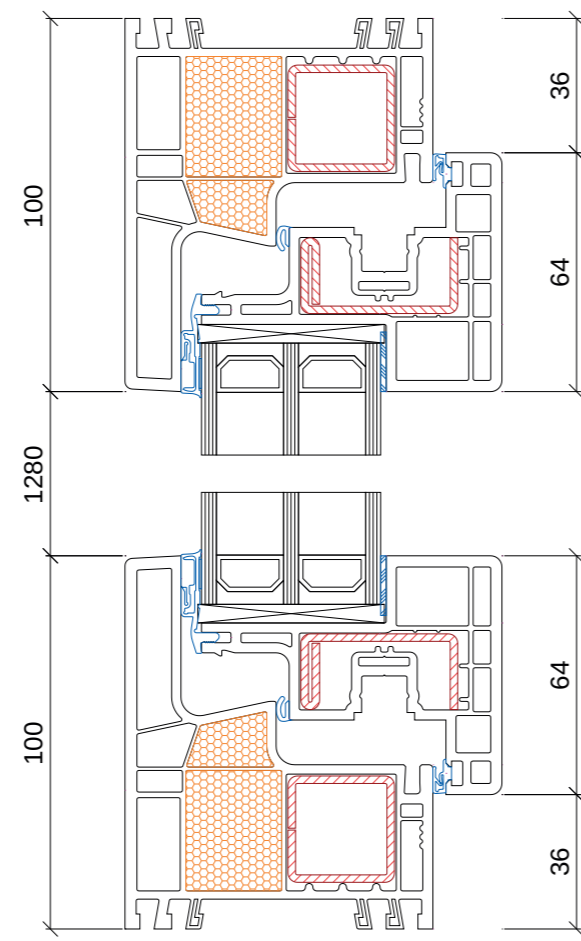

Acrylcolor

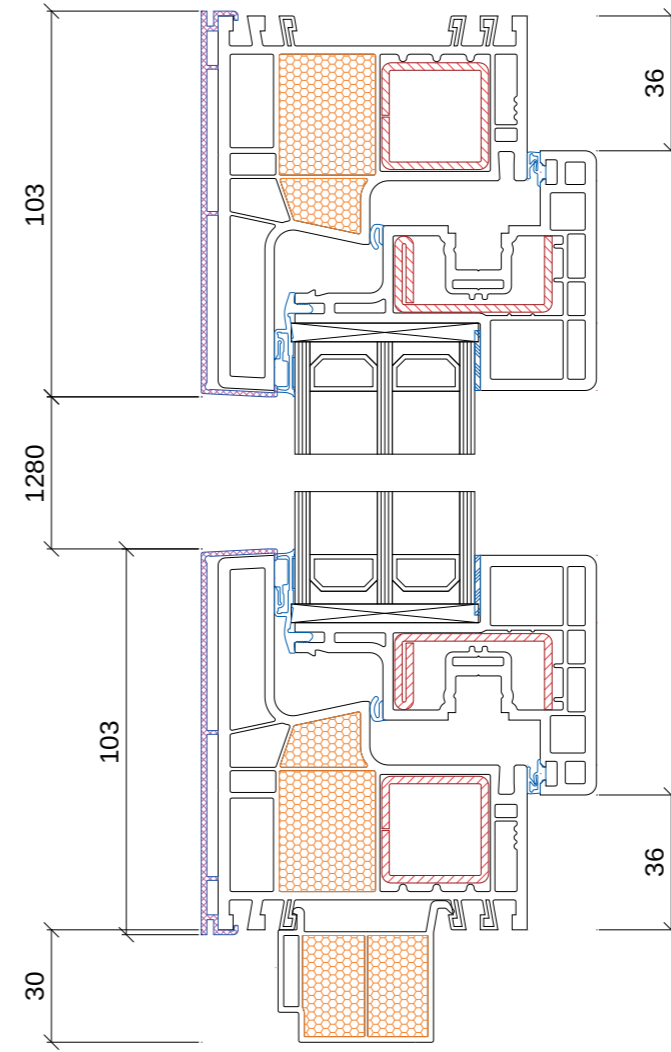

mit Aludeckschale

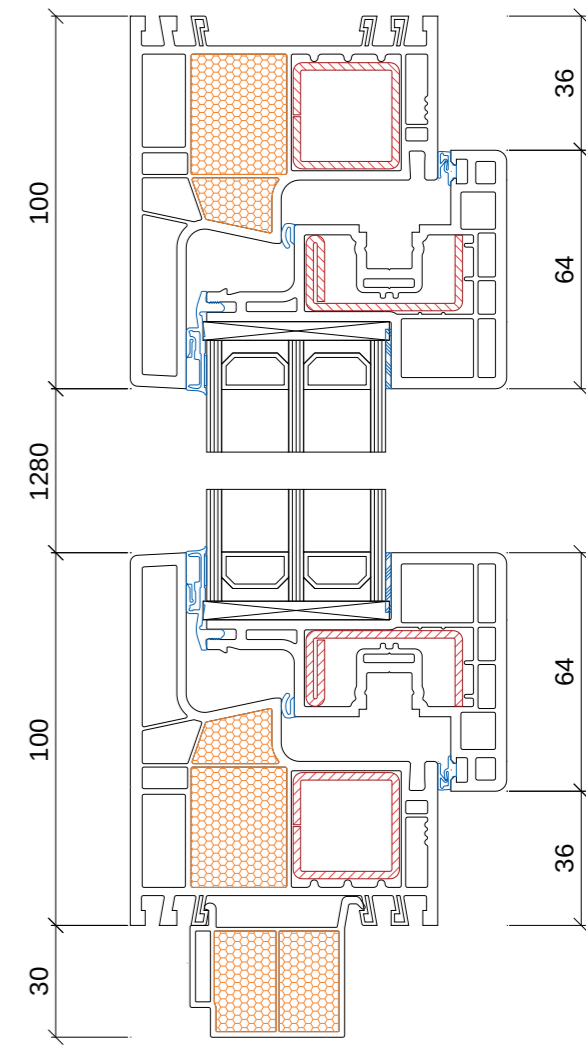

Acrylcolor

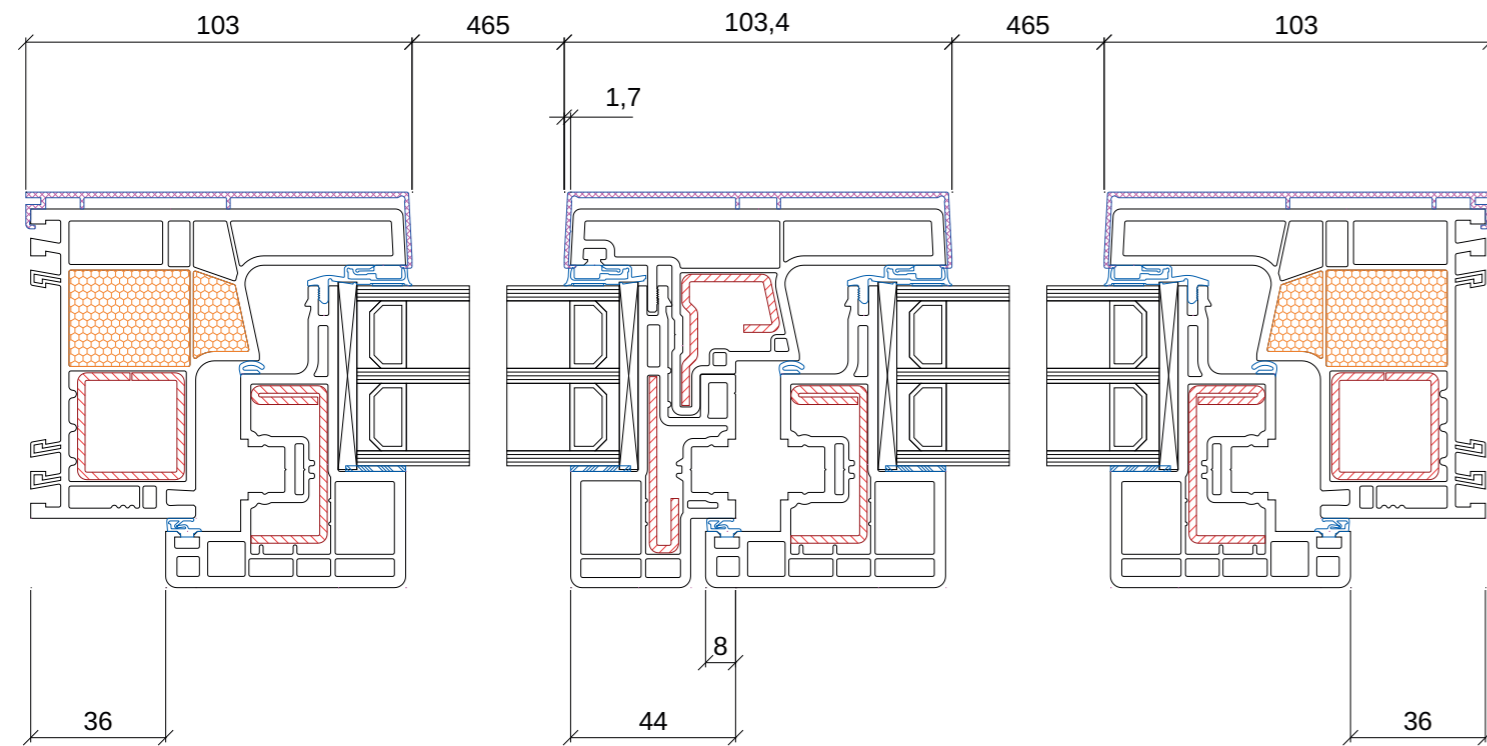

Stulp 5260 mit Aludeckschale

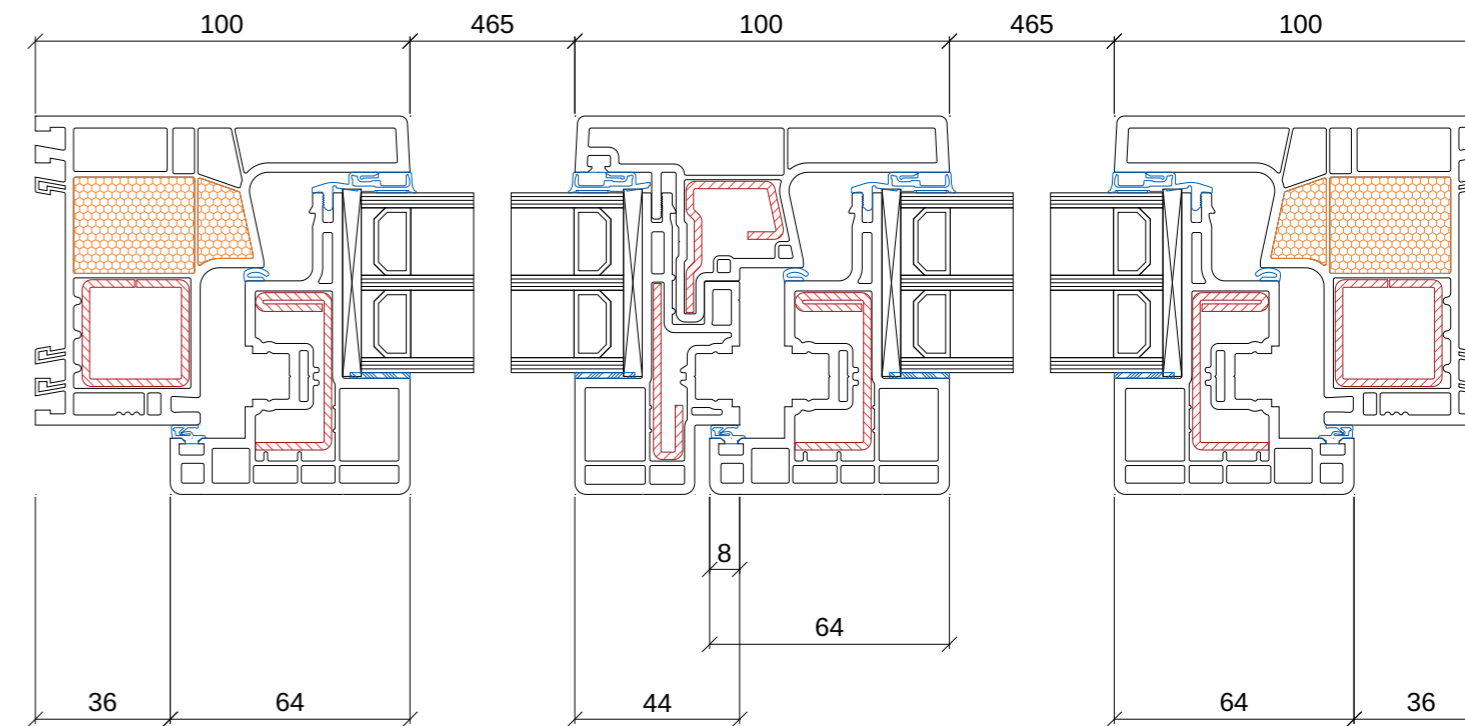

Stulp 5260 Acrylcolor

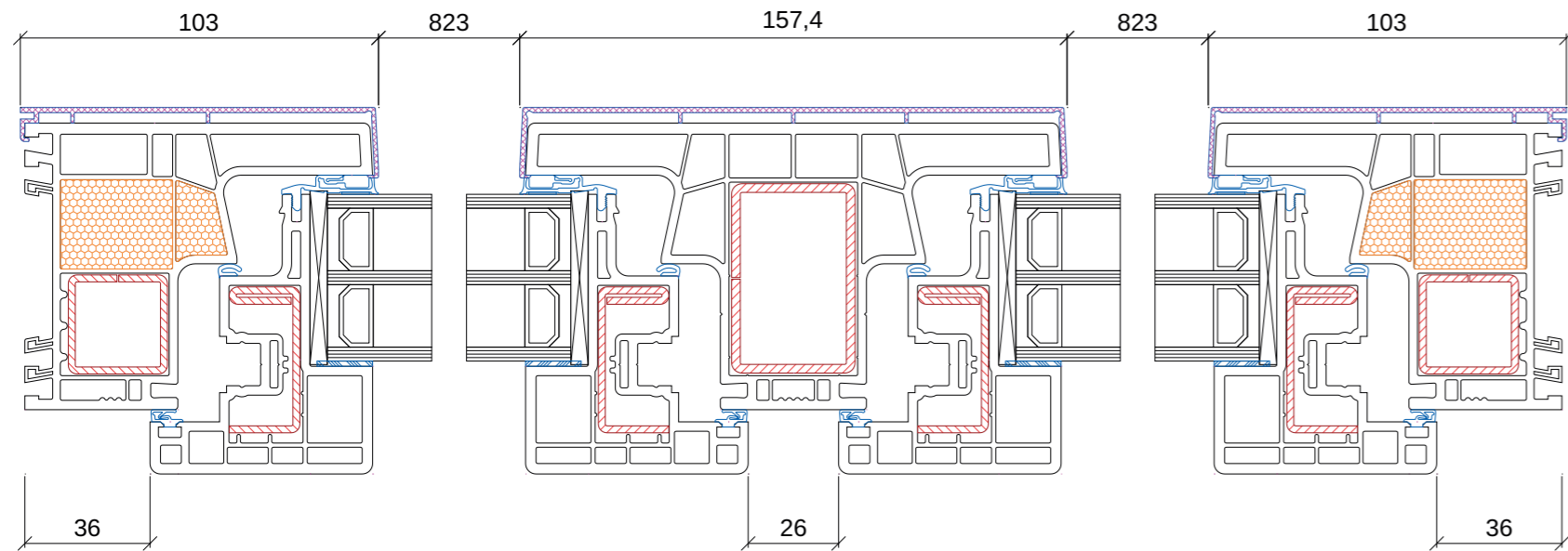

Pfosten 5063 mit Acrylcolor

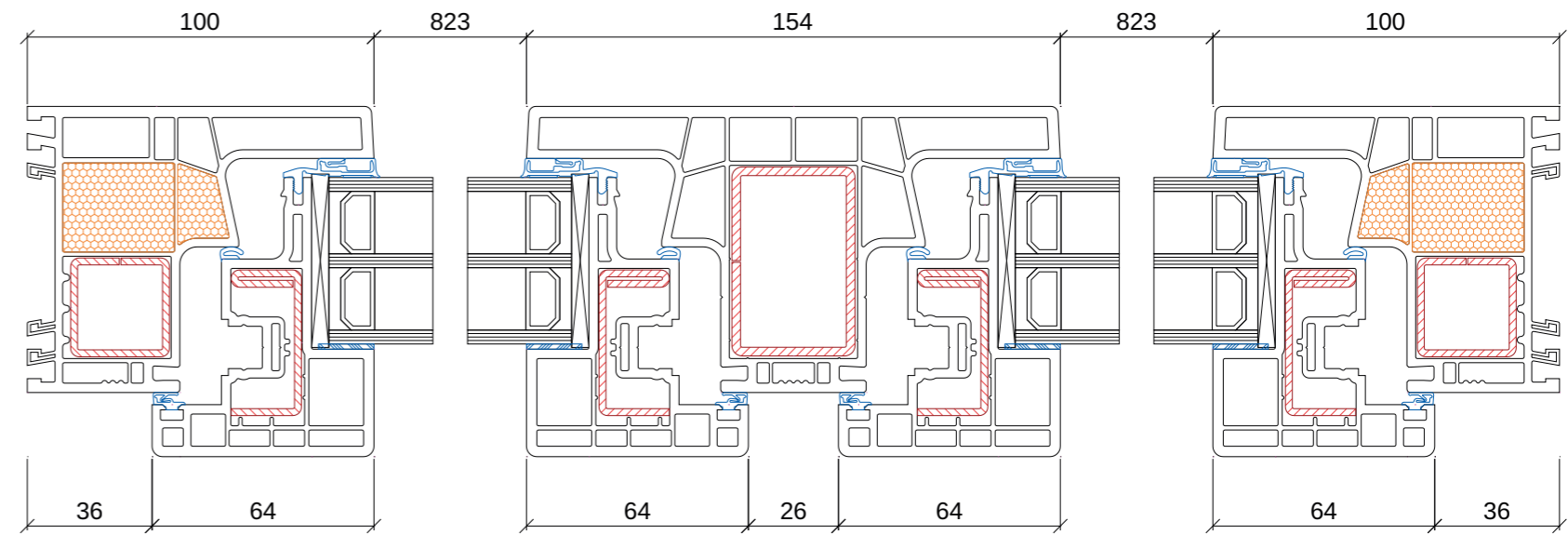

Pfosten 5063 Acrylcolor



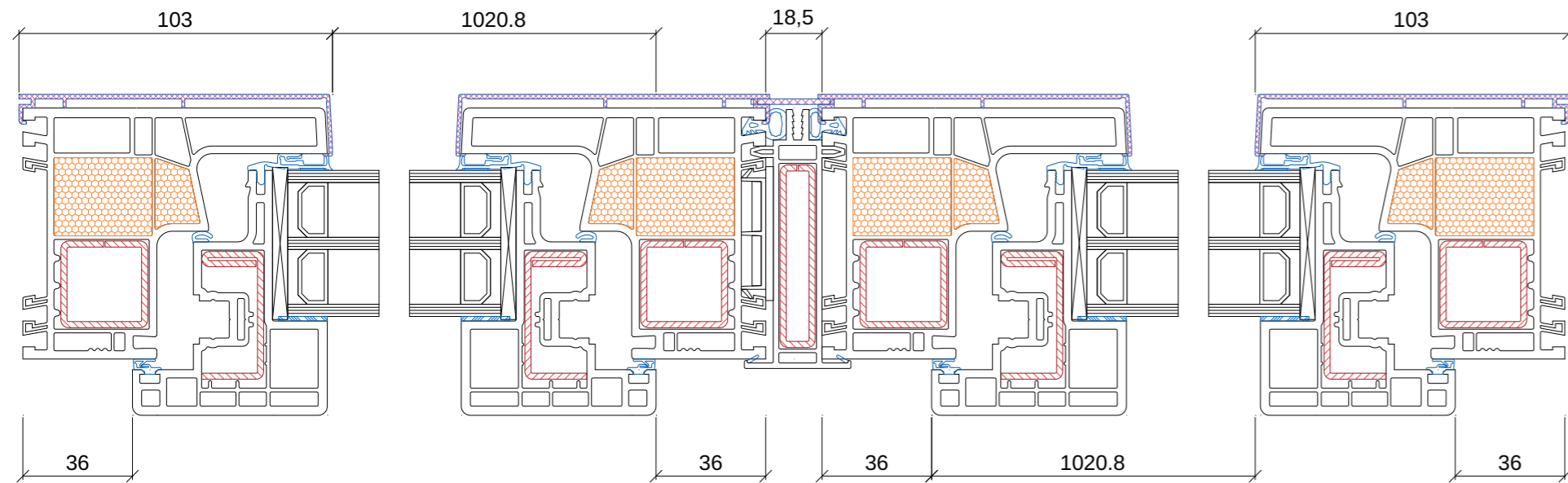

Kopplung 6281 mit Aludeckschale

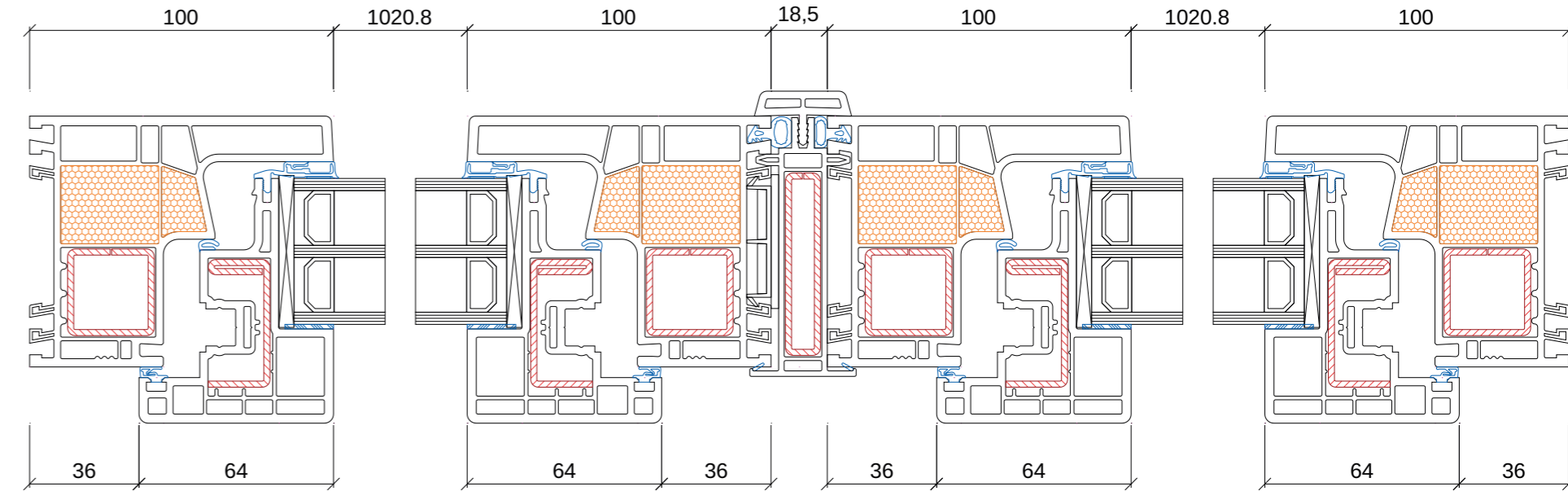

Kopplung 6281 Acrylcolor

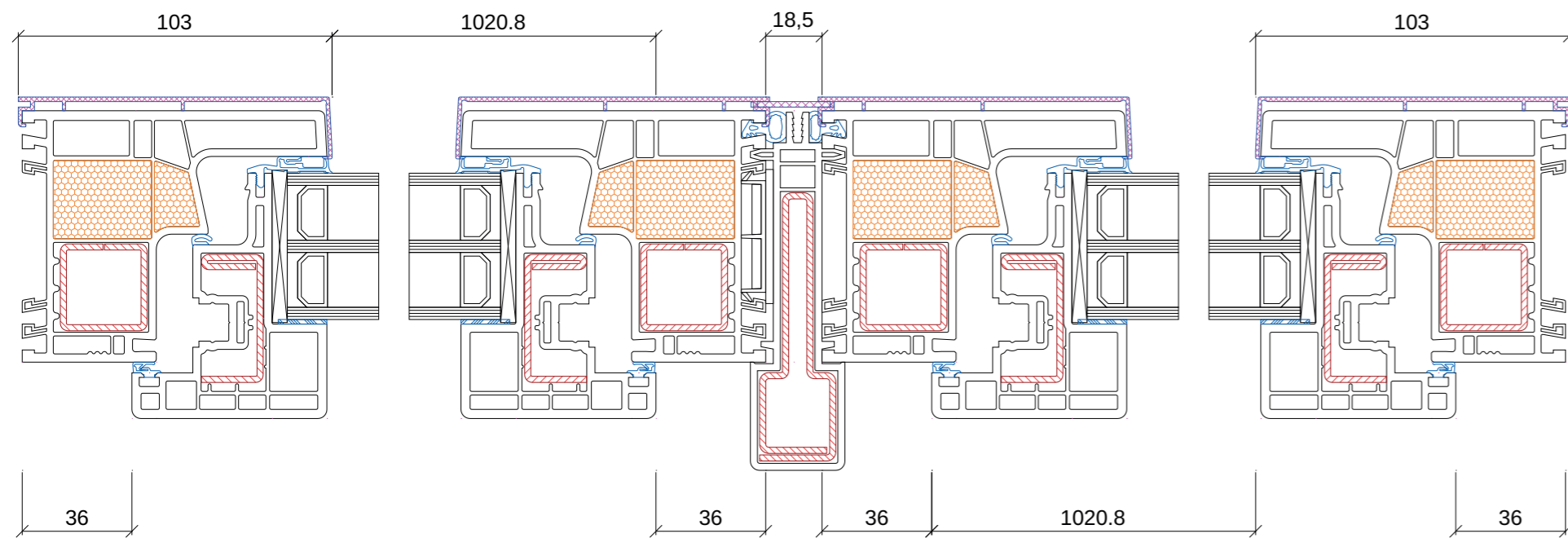

Statikkopplung 5204 mit Aludeckschale

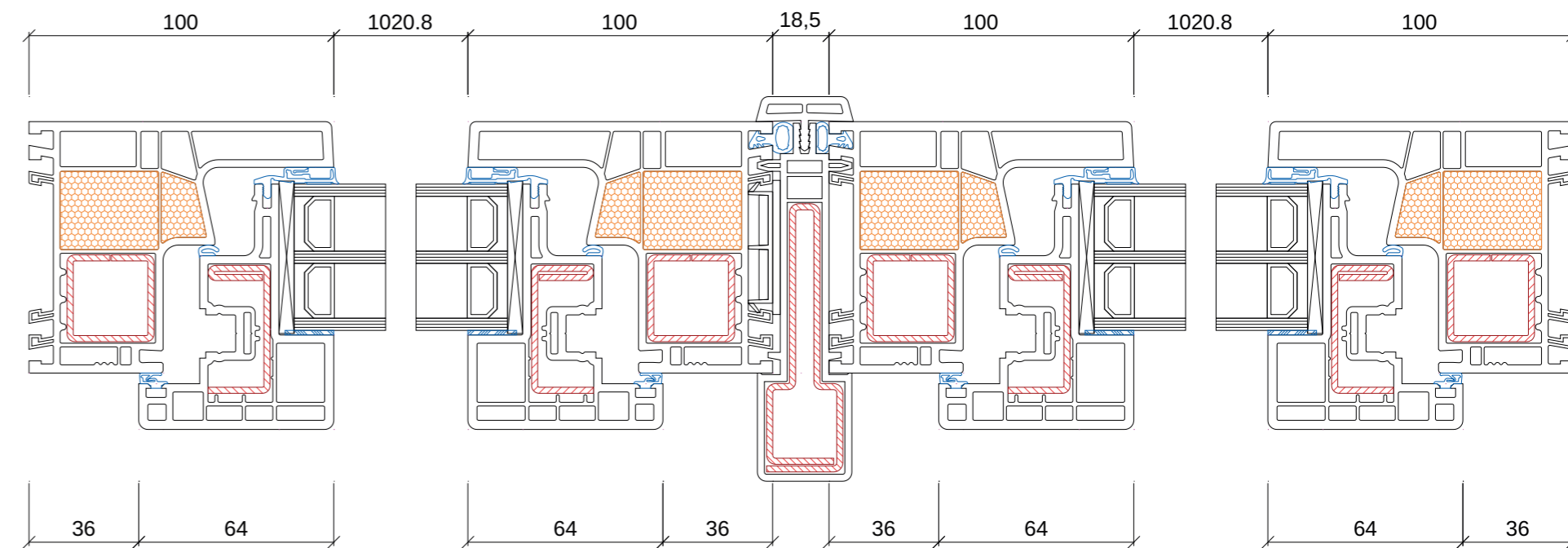

Statikkopplung 5204 mit Acrylcolor

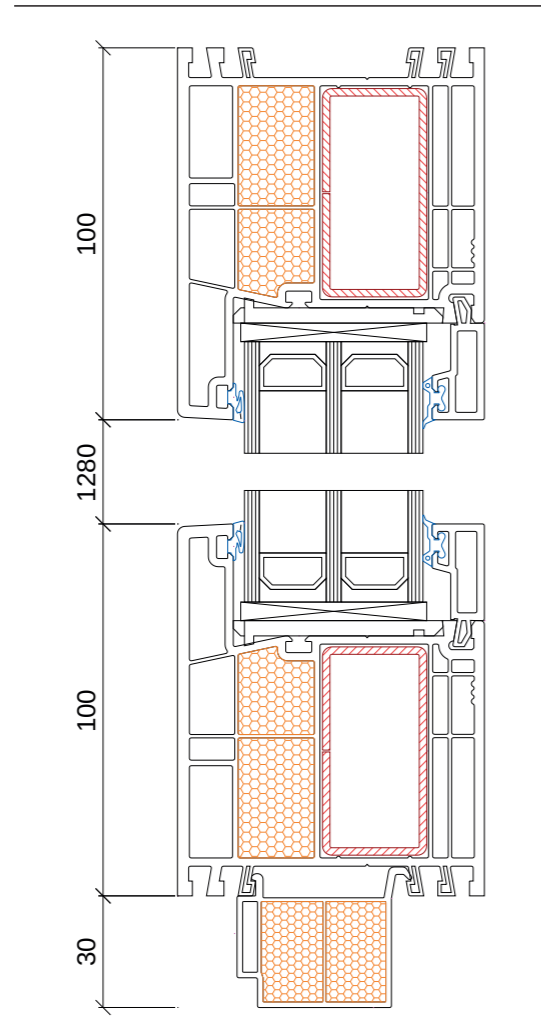

Festverglasung 7202 mit Anschluss Acrylcolor

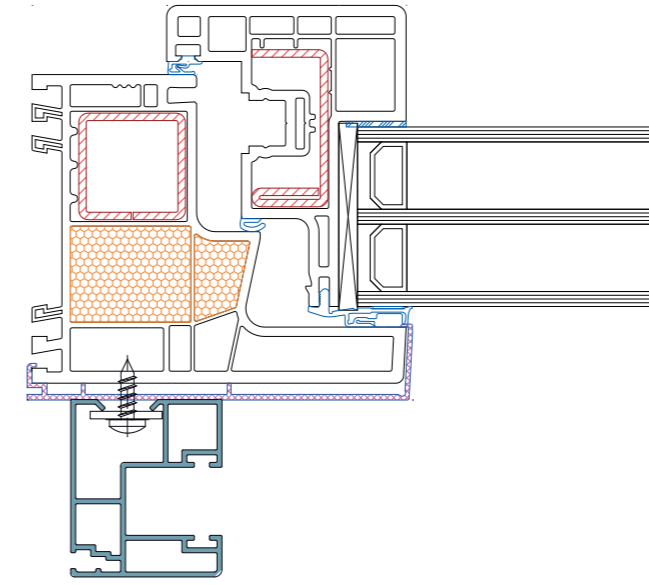

mit Aludeckschale  
und Rollladenführung

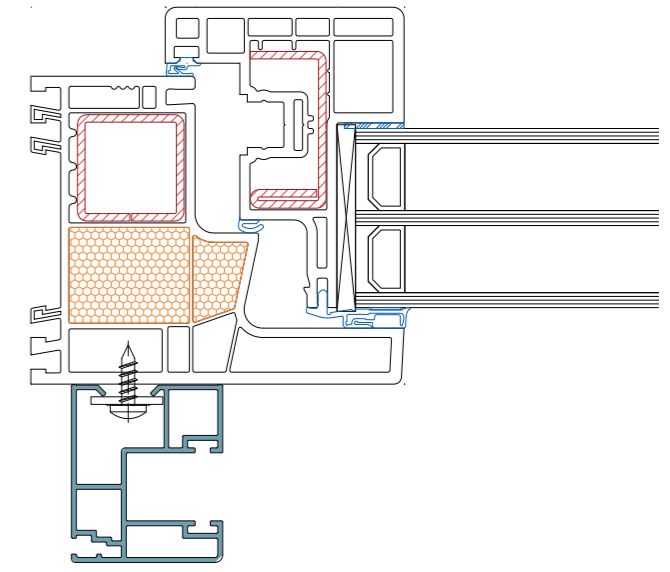

Acrylcolor  
und Rollladenführung

# PURE [WOOD]

Holz und Glas perfekt vereint.



# PURE [WOOD] - zertifizierte Nachhaltigkeit

Die Deutsche Gesellschaft für Nachhaltiges Bauen (DGNB) zertifiziert Bauprojekte basierend auf **nachhaltige Kriterien**.

Die Produktdatenbank „**DGNB Navigator**“ enthält nur Produkte die den Kriterien des DGNB gerecht werden und deren Anforderungen. Ein wichtiges **Tool für Architekten und Bauplaner zur Zertifizierung des Bauvorhabens**.

Das vertrauenswürdige Label hat eine positive Auswirkung auf den finalen Score und damit auch auf die **KfW40 NH Förderung**.

[www.dgnb-navigator.de](http://www.dgnb-navigator.de)



# PURE [WOOD]

Modernes, reduziertes Design.

Schmale Rahmen.

Keine sichtbaren Metallteile.

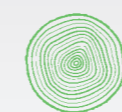

Holz aus FSC-kontrolliertem Anbau.



Herstellung mit geringem Energieaufwand:  $\pm 900 \text{ MJ/m}^2$ .



Innen lösemittelfreie Öle und Lasuren.

Außen Holz in „Alu-Optik“ möglich dank innovativer Lackierung.



PURE[WOOD]



# PURE [WOOD]

Modernes, reduziertes Design.

Schmale Rahmen.

Keine sichtbaren Metallteile.



Holz aus FSC-kontrolliertem Anbau.



Herstellung mit geringem Energieaufwand:  $\pm 900 \text{ MJ/m}^2$ .



Innen lösemittelfreie Öle und Lasuren.

Außen Holz in „Alu-Optik“ möglich dank innovativer Lackierung.

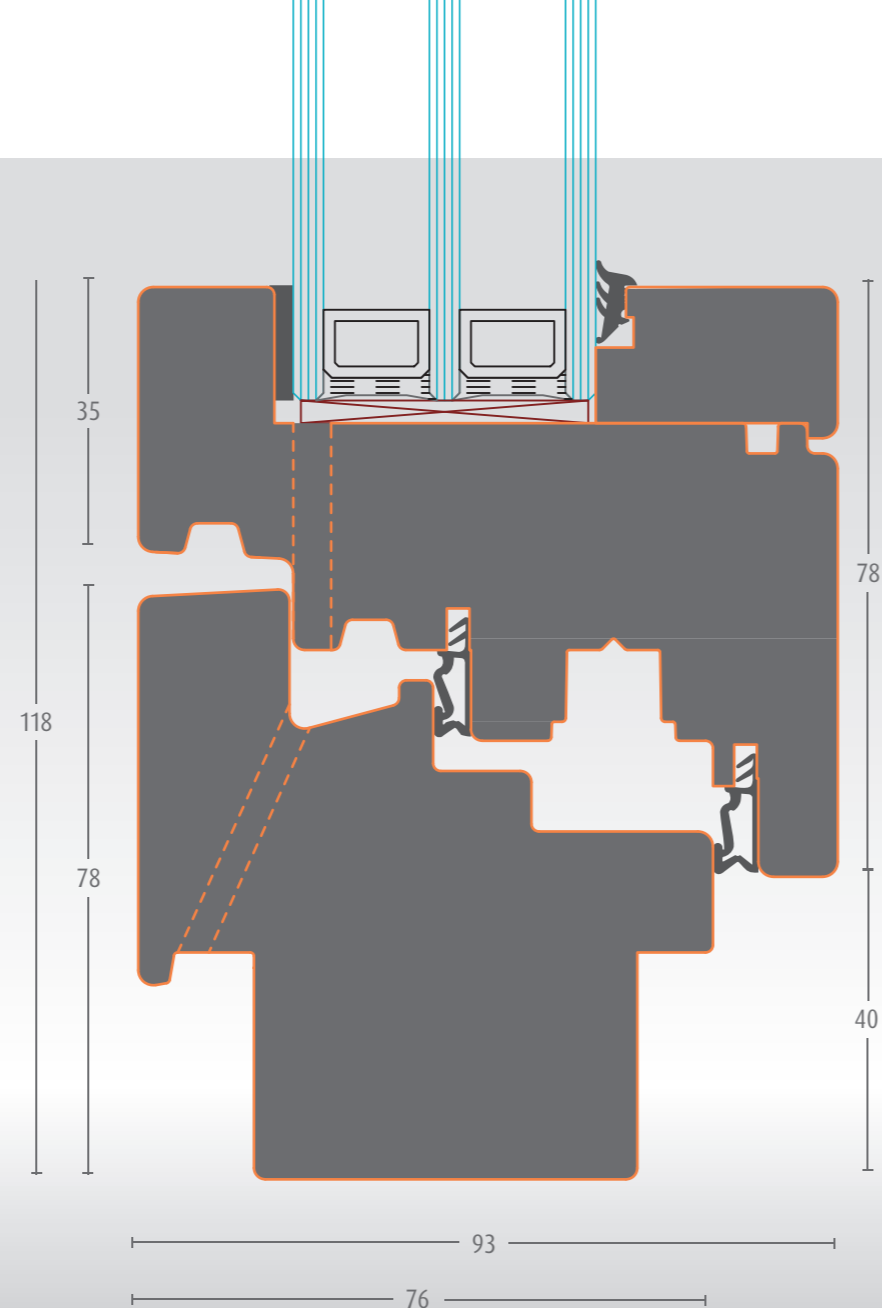

# PURE [WOOD]

Bautiefe 93 mm

Ansichtsbreite 118 mm

Uf 0,98  $\text{W/m}^2\text{k}$

Ug (48 mm) 0,50  $\text{W/m}^2\text{k}$

Uw 0,82  $\text{W/m}^2\text{k}$



\*Zum Vergleich: Reine Aluminiumfenster ca.  $5.200 \text{ MJ/m}^2$ . Der Energieaufwand bei Holz-Alu-Fenstern liegt bei ca.  $1.700 \text{ MJ/m}^2$  |  $\text{MJ/m}^2$  = Megajoule pro Quadratmeter

Das Upgrade!

Schlanker ip-Steckgriff  
mit stabiler Verschraubung  
gegen Aufpreis.



Griff Edelstahl  
Pure Eiche geölt



Griff schwarz eloxiert  
Pure Eiche geölt



Griff mittelbronze eloxiert  
Pure Eiche geölt

ip-Select-Griffe

im besonderen Design  
in verschiedenen Eloxalen  
gegen Aufpreis.

Weitere Steckgriffe  
auf Anfrage möglich.

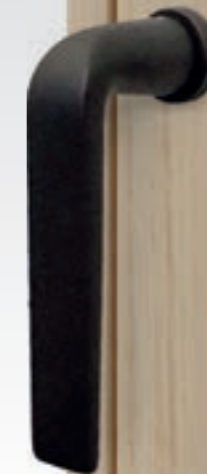

Design Hans Kollhoff  
Pure Eiche geölt



Design Jasper Morrison  
Pure Eiche geölt



Design Heike Falkenberg  
Pure Eiche geölt

## Holzfarben für Außen und Innen (Holzart | Farbe; weitere Farben auf Anfrage)



## Holzfarben nur für Innen



Aufgrund drucktechnischer Gegebenheiten können Farbabweichungen zwischen den Darstellungen im Katalog und den Original-Produkten auftreten. Ihr Fachhändler zeigt Ihnen gerne die Original-Farbmuster.

Aufgrund drucktechnischer Gegebenheiten können Farbabweichungen zwischen den Darstellungen im Katalog und den Original-Produkten auftreten. Ihr Fachhändler zeigt Ihnen gerne die Original-Farbmuster.

# PURE [WOOD]

TECHNIK

PURE [WOOD]

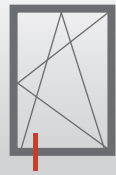

unten

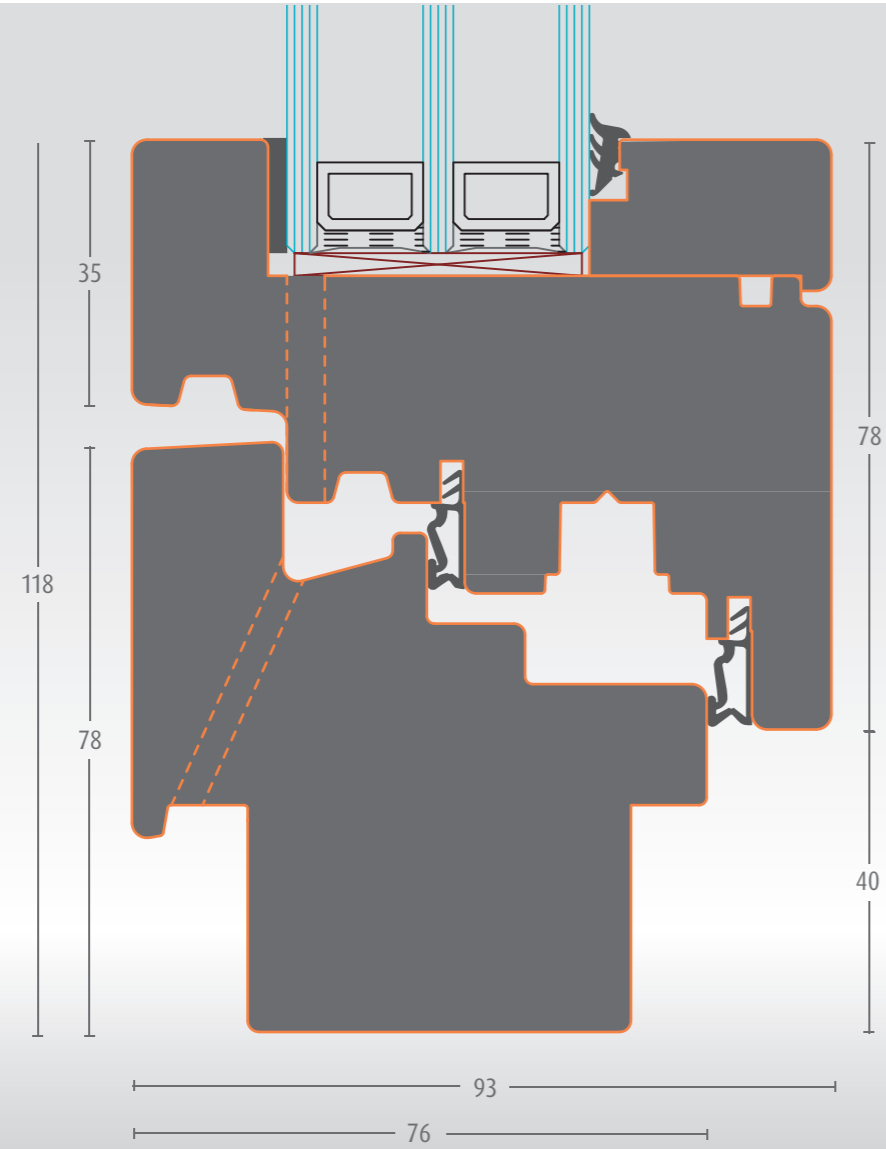

Alubankanschluss

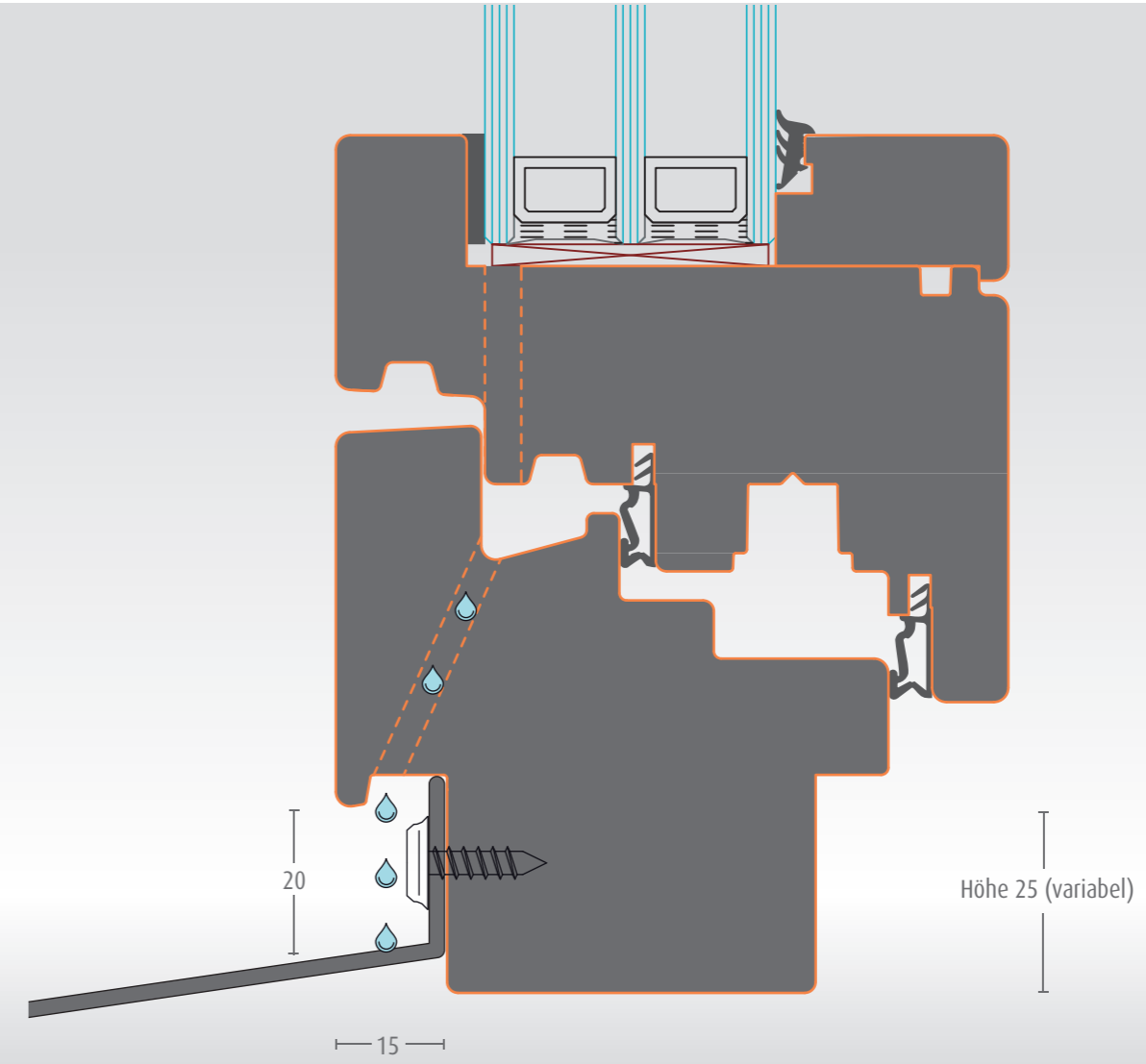



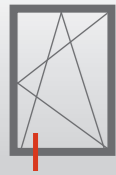

Steinbankanschluss

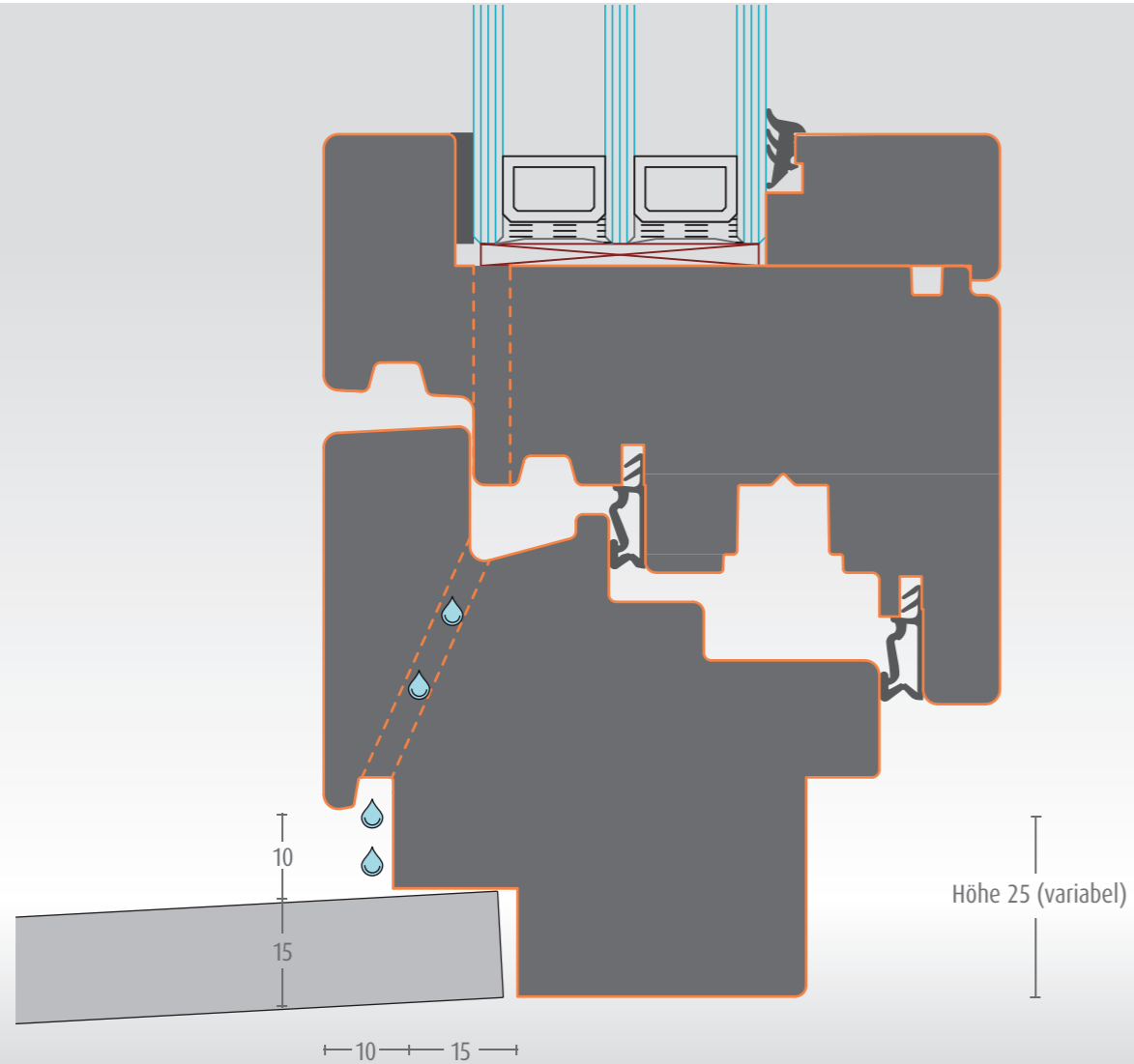

oben/seitlich

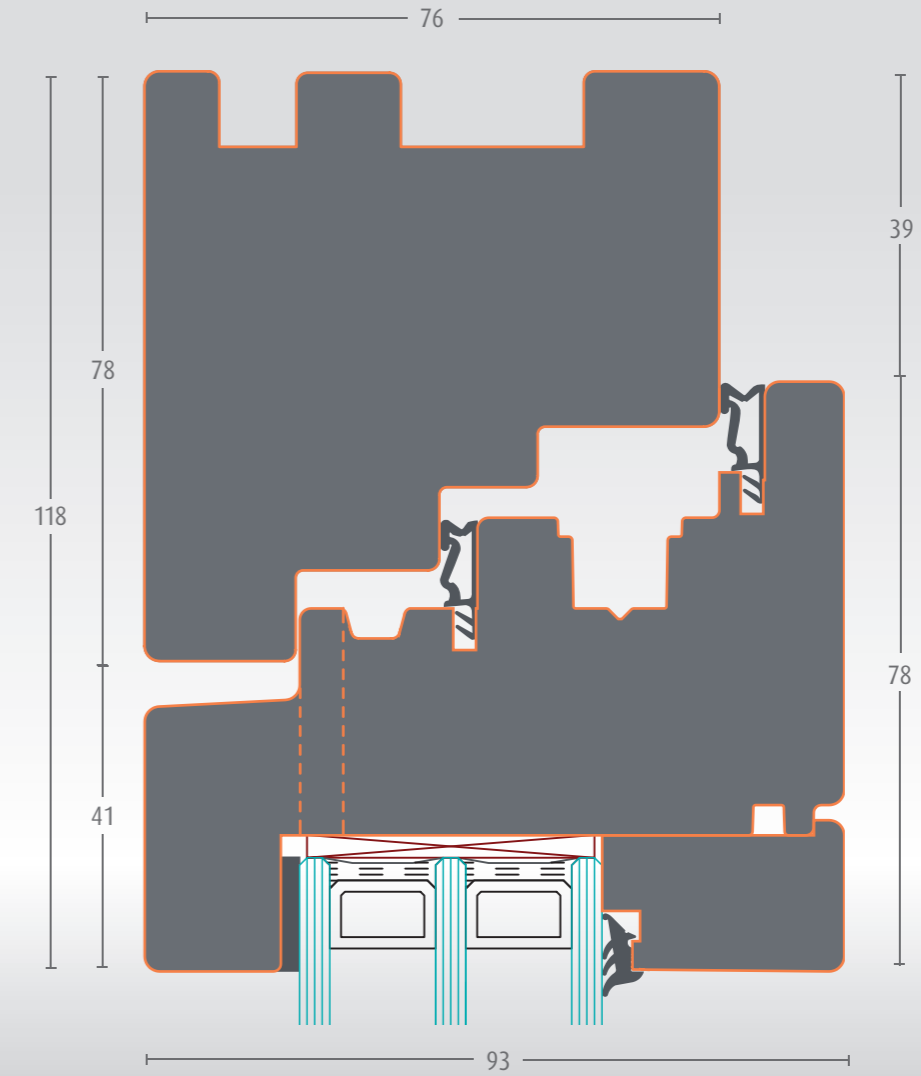

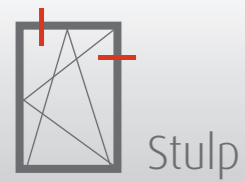
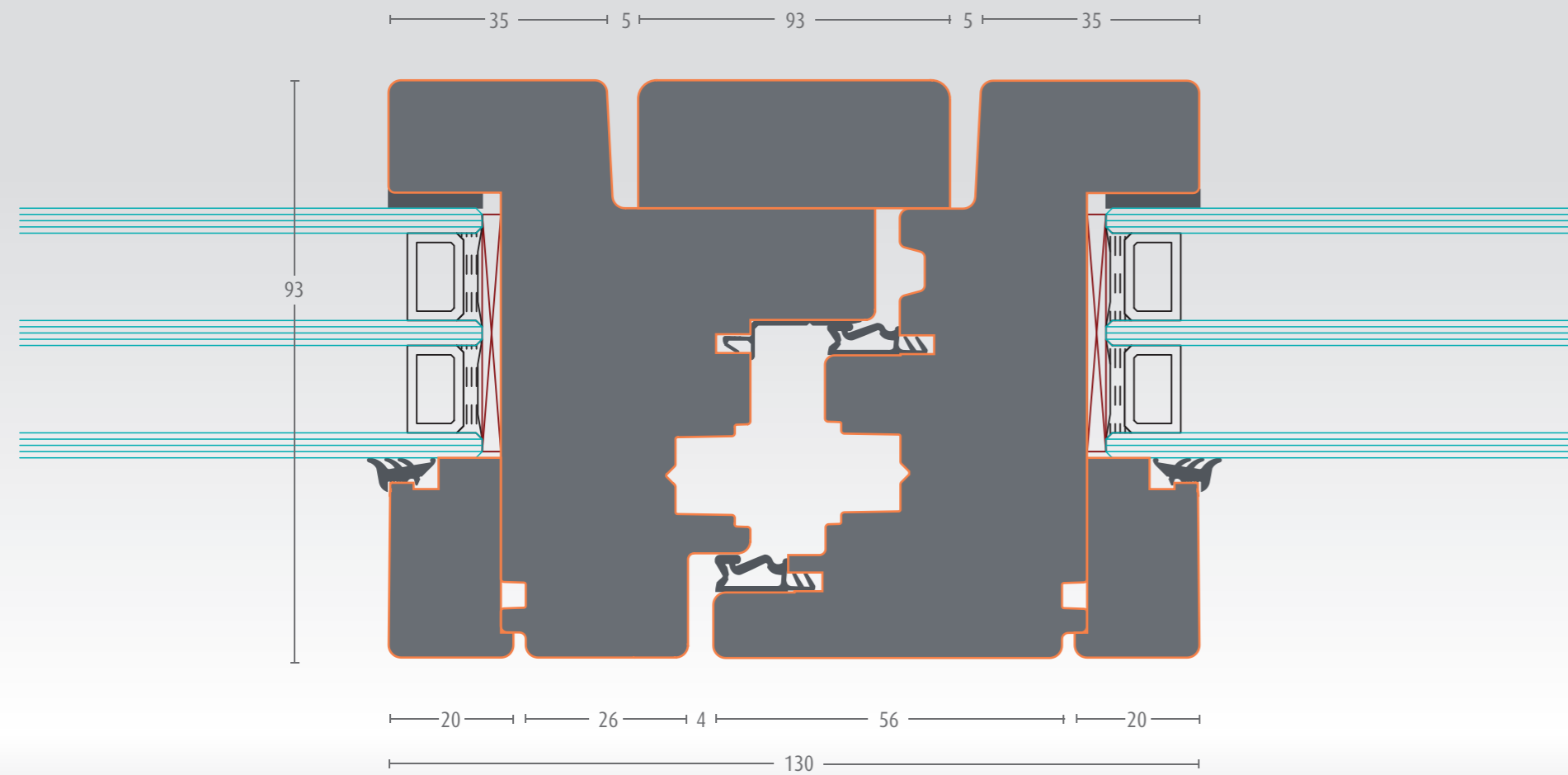

Stulp



Bodenschwelle 20mm

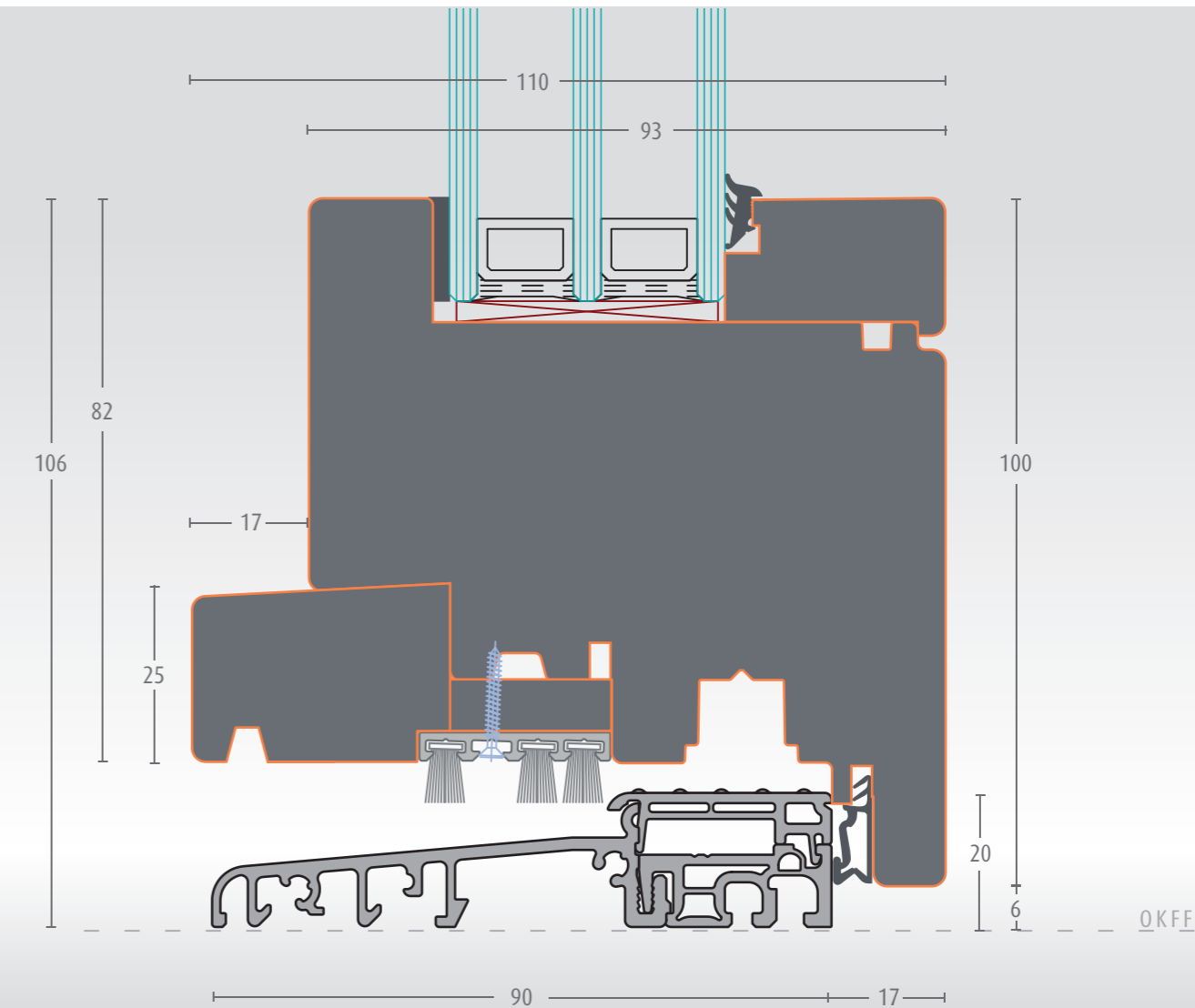



Frank Laurich

Tel. 02564-39554-0  
f.laurich@fl-fenster.de